

INSISTING ON TAIWANESE MANUFACTURING

PARTIAL
PRESSURE FOOT
2025

2025



RENJYI

with
Quality.

Made in Taiwan
All includes
Internal parts.



➤ MAIN PRODUCTS 

SNAP ON SEWING FEET (5MM) ----- PAGE 1 ~ 8
 INCLUDES THE LOW/HIGH/SLANT HINGED SEWING FEET.

LOW SOLID SEWING FEET (5-7MM) ----- PAGE 9 ~ 16
 INCLUDES STRAIGHT STITCH / 5MM/ 7MM ZIG ZAG WIDTH

STRAIGHT STITCH SEWING FEET ----- PAGE 18 ~ 22
 INCLUDES THE LOW/HIGH/SLANT HINGED SEWING FEET.

HIGH SOLID SEWING FEET (INDUSTRIAL DESIGN) ----- PAGE 23 ~ 25
 INCLUDES THE INDUSTRIAL DESIGN SEWING FEET

SNAP ON SEWING FEET (7MM) ----- PAGE 26 ~ 34
 INCLUDES THE LOW/HIGH/SLANT HINGED SEWING FEET.

SNAP ON SEWING FEET (9MM) ----- PAGE 35 ~ 38
 SNAP ON ONLY (NO ANY HINGED)

OLD TYPE 6MM SEWING FEET (6MM) ----- PAGE 39 ~ 41
 FOR 155964 & 542167 SNAP ON & SOLID FEET

OVER LOCK & COVER STITCH SEWING FEET ----- PAGE 42 ~ 47
 TYPE O N E L ----- PAGE 76 ~ 78

THE SHANK ADAPTER ----- PAGE 48 ~ 50
 INCLUDES LOW / HIGH / SUPER HIGH / SLANT SHANK

NOT REFLECTED SEWING FEET ----- PAGE 51 ~ 53
 NOT FOR REGULAR / UNIVERSAL

POPULAR SEWING FEET KIT ----- PAGE 54 ~ 56
 DESIGN YOUR OWN SEWING FEET KIT WITH US

BOBBINS / BOBBIN CASE ----- PAGE 70 ~ 71
 WRITE MAIL TO US IF YOU CANNOT FIND THE PRODUCTS

2016-2025 NEW PRODUCTS ----- PAGE 72
 ASK US FOR MORE!

THE LEFT NEEDLE POSITION SEWING FEET ----- PAGE 75 ~ 76
 FOR COMPUTER DESIGN SEWING MACHINE ONLY

SUPER HIGH SEWING FEET ----- PAGE 82

➤ ONE-STOP SERVICE PRODUCTS

DRESS FORM -----	PAGE 17
MAT -----	PAGE 57 ~ 58
ROTARY CUTTER ---	PAGE 59 ~ 60
QUILTING RULER ---	PAGE 61 ~ 64
SEWING TOOL -----	PAGE 66 ~ 69
BUTTON PLIERS-----	PAGE 75
SEWING NEEDLES --	PAGE 79
SEWING MACHINES --	PAGE 80
SEWING THREADS ----	PAGE 81



CANNOT FIND PRODUCTS?
 HOW COME!
 WRITE MAIL TO US
renjyico1965@gmail.com
 contact person : Calvin Lin (CEO)

RENUYI

MADE IN TAIWAN



ONE STEP
Fits Our Shank adapter

Low shank : RJ-7300 / RJ-801 / RJ-803
RJ-7300J / RJ-7P00 / RJ-7100
RJ-7N00 / RJ-7300N/RJ-7300NP
High shank : RJ-7300H / RJ-801H /
RJ-801H-BR / JS-001H

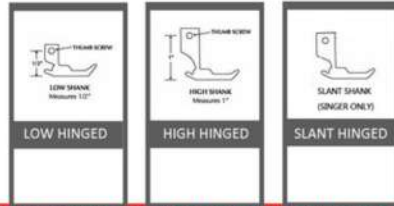

ALL SNAP ON (ONE STEP) SEWING FEET CAN BE MADE IN THE FOLLOWING TYPE

機
縫

台灣製造 一品質 服務客製化

1. WIDTH 7MM
MAX ZIG ZAG WIDTH 5MM



ZIG ZAG FOOT (ONE STEP)

MODEL NO	RJ-7301	MODEL NO	RJ-7301-J	MATERIAL	Zinc Alloy
Description	REGULAR	Description	WITH A MARK	MOQ	Depends
MODEL NO	RJ-7301G				
Description	back side with little groove				
MODEL NO	RJ-7301NG				
Description	back side NO CUT OFF				
MODEL NO	RJ-7301N				
Description	Front side with A mark				

ZIG ZAG FOOT (LOW HINGED)

MODEL NO	RJ-720L	MODEL NO	RJ-720LNG
Description	REGULAR	Description	back side NO CUT OFF
MODEL NO	RJ-720LG		
Description	back side with little groove		

ZIG ZAG FOOT (HIGH HINGED)

MODEL NO	RJ-720H	MODEL NO	RJ-720HNG
Description	REGULAR	Description	back side NO CUT OFF
MODEL NO	RJ-720HG		
Description	back side with little groove		

ZIG ZAG FOOT (SLANT HINGED)

MODEL NO	RJ-720S	MODEL NO	RJ-720SNG
Description	REGULAR	Description	back side NO CUT OFF
MODEL NO	RJ-720SG		
Description	back side with little groove		



ZIG ZAG FOOT (ONE STEP)
PLASTIC (WHITE COLOR)

MODEL NO	RJ-7301P	MATERIAL	PLASTIC
Description	Plastic zigzag foot (N TEFLON)	MOQ	DEPENDS

ZIG ZAG FOOT (PLASTIC) (LOW HINGED)

MODEL NO	RJ-720LP
Description	Plastic zigzag foot (N TEFLON)

ZIG ZAG FOOT (PLASTIC) (HIGH HINGED)

MODEL NO	RJ-720HP
Description	Plastic zigzag foot (N TEFLON)

ZIG ZAG FOOT (PLASTIC) (LOW HINGED)

MODEL NO	RJ-720SP
Description	Plastic zigzag foot (N TEFLON)



MADE IN TAIWAN SINCE 1951 NOW & FOREVER

THE SEWING MACHINE SEWING FEET FACTORY



ONE STEP Fits Our Shank adapter

Low shank : RJ-7300 / RJ-801 / RJ-803
 RJ-7300J / RJ-7P00 / RJ-7100
 RJ-7N00 / RJ-7300N/RJ-7300NP
 High shank : RJ-7300H / RJ-801H /
 RJ-801H-BR / JS-001H

機縫

台灣製造 品質服務客製化

2. WIDTH 7MM
 MAX ZIG ZAG WIDTH 5MM

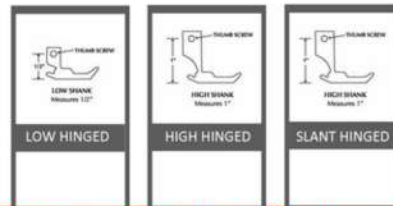

ALL SNAP ON (ONE STEP) SEWING FEET CAN BE MADE IN THE FOLLOWING TYPE



SLIDING
 BUTTONHOLE FOOT (ONE STEP)

MODEL NO	RJ-7302
Description	SLIDING

MATERIAL	PLASTIC
MOQ	DEPENDS

➔

BUTTONHOLE FOOT
 (LOW HINGED)

MODEL NO	RJ-703L
Description	ALL PLASTIC

MODEL NO	RJ-703LZ
Description	plastic bottom w/ zink shank

➔

BUTTONHOLE FOOT
 (SLANT HINGED)

MODEL NO	RJ-703SZ
Description	plastic bottom w/ zink shank

➔

BUTTONHOLE FOOT
 (HIGH HINGED)

MODEL NO	RJ-703H
Description	ALL PLASTIC

MODEL NO	RJ-703HZ
Description	plastic bottom w/ zink shank



SLIDING (METAL)
 BUTTONHOLE FOOT (ONE STEP)

MODEL NO	RJ-7302MR
Description	SLIDING

MATERIAL	METAL
MOQ	Depends

➔

BUTTONHOLE FOOT
 (LOW HINGED)

MODEL NO	RJ-703LMR
Description	ALL METAL

MODEL NO	RJ-703LMRP
Description	metal bottom w/ plastic shank

➔

BUTTONHOLE FOOT
 (SLANT HINGED)

MODEL NO	RJ-703SMR
Description	ALL METAL

➔

BUTTONHOLE FOOT
 (HIGH HINGED)

MODEL NO	RJ-703HMR
Description	ALL METAL



ADJUSTABLE (PLASTIC)
 BUTTONHOLE FOOT (ONE STEP)

Clear view : RJ-1932SP-CR
 White color : RJ-1932SP

MODEL NO	RJ-1932SP
Description	white color

MODEL NO	RJ-1932SP-CR
Description	Clear view

MATERIAL	Plastic
MOQ	Depends

➔

BUTTONHOLE FOOT
 (LOW HINGED)

MODEL NO	RJ-1932L
Description	white color

MODEL NO	RJ-1932L-CR
Description	white color

➔

BUTTONHOLE FOOT
 (SLANT HINGED)

MODEL NO	RJ-1932S
Description	white color

MODEL NO	RJ-1932S-CR
Description	white color

➔

BUTTONHOLE FOOT
 (HIGH HINGED)

MODEL NO	RJ-1932H
Description	white color

MODEL NO	RJ-1932H-CR
Description	white color





ONE STEP
Fits Our Shank adapter

Low shank : RJ-7300 / RJ-801 / RJ-803
 RJ-7300J / RJ-7P00 / RJ-7100
 RJ-7N00 / RJ-7300N/RJ-7300NP
 High shank : RJ-7300H / RJ-801H /
 RJ-801H-BR / JS-001H

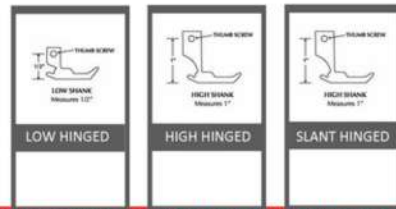

ALL SNAP ON (ONE STEP) SEWING FEET CAN BE MADE IN THE FOLLOWING TYPE

機
縫

台灣製造 一品質 服務客製化

3. WIDTH 7MM
MAX ZIG ZAG WIDTH 5MM



SLIDING
BUTTONHOLE FOOT (ONE STEP)

MODEL NO	RJ-7302-PG
Description	SLIDING

MATERIAL	PLASTIC
MOQ	100 PCS



ADJUSTABLE
BUTTONHOLE FOOT (ONE STEP)

MODEL NO	RJ-7302MPMG
Description	ADJUSTABLE

MATERIAL	METAL+PLASTIC
MOQ	100 PCS



SLIDING
BUTTONHOLE FOOT (ONE STEP)

MODEL NO	RJ-7302-ME
Description	SLIDING

MATERIAL	METAL+PLASTIC
MOQ	100 PCS



ADJUSTABLE + SLIDING
BUTTONHOLE FOOT ATTACHMENT
(ONE STEP)

MODEL NO	RJ-7302-MPGR
Description	ADJ. + SLIDING

MATERIAL	PLASTIC+METAL
MOQ	100 SETS



SATIN STITCH FOOT (ONE STEP)

MODEL NO	RJ-7303
Description	CLEAR VIEW

MATERIAL	PLASTIC+METAL
MOQ	DEPENDS



MODEL NO	RJ-721L
Description	CLEAR VIEW



MODEL NO	RJ-721S
Description	CLEAR VIEW



MODEL NO	RJ-721H
Description	CLEAR VIEW



OPEN TOE
SATIN STITCH FOOT (ONE STEP)

MODEL NO	RJ-7303-OT
Description	OPEN TOE

MATERIAL	PLASTIC
MOQ	100 PCS



BRAIDING FOOT (ONE STEP)

MODEL NO	RJ-7320
Description	BRAIDING

MATERIAL	ZINK+METAL
MOQ	100 PCS



JEANS FOOT (ONE STEP)

MODEL NO	RJ-6717
Description	JEANS

MATERIAL	ZINC ALLOY
MOQ	100 SETS



FLAT FELLED SEAM FOOT

MODEL NO	RJ-7332-M4
Description	4MM

MODEL NO	RJ-7332-M6
Description	6MM

MATERIAL	ZINC ALLOY
MOQ	300 PCS



RENUYI

MADE IN TAIWAN



ONE STEP
Fits Our Shank adapter

Low shank : RJ-7300 / RJ-801 / RJ-803
RJ-7300J / RJ-7P00 / RJ-7100
RJ-7N00 / RJ-7300N/RJ-7300NP
High shank : RJ-7300H / RJ-801H /
RJ-801H-BR / JS-001H

ALL SNAP ON (ONE STEP) SEWING FEET CAN BE MADE IN THE FOLLOWING TYPE



機
縫

台灣製造 一品質 服務客製化

4. WIDTH 7MM
MAX ZIG ZAG WIDTH 5MM



BUTTON SEWING FOOT
(ONE STEP)

MODEL NO	RJ-7305
Description	CLEAR

MATERIAL	PLASTIC
MOQ	DEPENDS

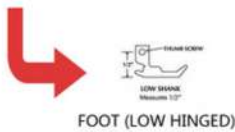

MODEL NO	RJ-729L
Description	CLEAR



MODEL NO	RJ-729S
Description	CLEAR

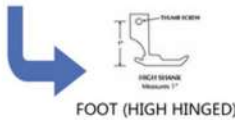

MODEL NO	RJ-729H
Description	CLEAR



3mm (1/8in.)
HEMMING FOOT
(ONE STEP)

MODEL NO	RJ-7307
Description	FLAT 3MM

MATERIAL	ZINC ALLOY
MOQ	100 PCS



MODEL NO	RJ-730L
Description	FLAT 3MM



MODEL NO	RJ-730S
Description	FLAT 3MM



MODEL NO	RJ-730H
Description	FLAT 3MM



3mm (1/8in.)
HEMMING FOOT
(ONE STEP)

MODEL NO	RJ-7307R
Description	ROUND 3MM

MATERIAL	ZINC ALLOY
MOQ	100 PCS



MODEL NO	RJ-717-1L
Description	ROUND 3MM



MODEL NO	RJ-717-1S
Description	ROUND 3MM



MODEL NO	RJ-717-1H
Description	ROUND 3MM



BLIND STITCH FOOT
(ONE STEP)

MODEL NO	RJ-7308
Description	ADJUSTABLE

MATERIAL	ZINC ALLOY + PLASTIC
MOQ	100 PCS



MODEL NO	RJ-723L
Description	ADJUSTABLE



MODEL NO	RJ-723S
Description	ADJUSTABLE



MODEL NO	RJ-723H
Description	ADJUSTABLE



MADE IN TAIWAN SINCE 1951 NOW & FOREVER

THE SEWING MACHINE SEWING FEET FACTORY

RENUYI

MADE IN TAIWAN

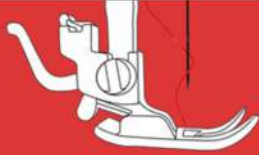

ONE STEP
Fits Our Shank adapter

Low shank : RJ-7300 / RJ-801 / RJ-803
RJ-7300J / RJ-7P00 / RJ-7100
RJ-7N00 / RJ-7300N/RJ-7300NP
High shank : RJ-7300H / RJ-801H /
RJ-801H-BR / JS-001H



ALL SNAP ON (ONE STEP) SEWING FEET CAN BE MADE IN THE FOLLOWING TYPE

機
縫

台灣製造 一品質 服務客製化

5. WIDTH 7MM
MAX ZIG ZAG WIDTH 5MM



3-HOLE CORDING FOOT
(ONE STEP)

MODEL NO	RJ-7309	MATERIAL	Zinc Alloy
Description	3-HOLE	MOQ	DEPENDS



MODEL NO	RJ-716L
Description	3-HOLE



MODEL NO	RJ-716S
Description	3-HOLE



MODEL NO	RJ-716H
Description	3-HOLE



OVER LOCK FOOT
(ONE STEP)

MODEL NO	RJ-7310	MATERIAL	Zinc Alloy
Description	SLIVER GUIDE	MOQ	DEPENDS



MODEL NO	RJ-731L
Description	SLIVER GUIDE



MODEL NO	RJ-731S
Description	SLIVER GUIDE



MODEL NO	RJ-731H
Description	SLIVER GUIDE



BLIND STITCH FOOT
(ONE STEP)

MODEL NO	RJ-7308M	MATERIAL	Zinc Alloy W/METAL
Description	ADJUSTABLE	MOQ	DEPENDS



MODEL NO	RJ-723LM
Description	ADJUSTABLE



MODEL NO	RJ-723SM
Description	ADJUSTABLE



MODEL NO	RJ-723HM
Description	ADJUSTABLE



OVER CASTING FOOT
(ONE STEP)

MODEL NO	RJ-7310B	MATERIAL	Zinc Alloy W/METAL
Description	BLACK GUIDE	MOQ	DEPENDS



MODEL NO	RJ-731LB
Description	BLACK GUIDE



MODEL NO	RJ-731SB
Description	BLACK GUIDE



MODEL NO	RJ-731HB
Description	BLACK GUIDE



HEMMING FOOT (NEW)

MODEL NO	RJ-7307R-R
Description	NEW
MATERIAL	ZINC ALLOY
MOQ	100 PCS

MINI CORDING FOOT

MODEL NO	RJ-604	MATERIAL	PLASTIC
Description	CLEAR	MOQ	100 PCS



RENUYI

MADE IN TAIWAN



ONE STEP
Fits Our Shank adapter

Low shank : RJ-7300 / RJ-801 / RJ-803
RJ-7300J / RJ-7P00 / RJ-7100
RJ-7N00 / RJ-7300N/RJ-7300NP
High shank : RJ-7300H / RJ-801H /
RJ-801H-BR / JS-001H



ALL SNAP ON (ONE STEP) SEWING FEET CAN BE MADE IN THE FOLLOWING TYPE

機
縫

台灣製造 一品質 服務客製化

6. WIDTH 7MM
MAX ZIG ZAG WIDTH 5MM



ADJUSTABLE
BINDING FOOT
(ONE STEP)

MODEL NO	RJ-6290	MATERIAL	Zinc Alloy W/PLASTIC
Description	CLEAR VIEW	MOQ	DEPENDS



MODEL NO	RJ-6287
Description	CLEAR VIEW



MODEL NO	RJ-6289
Description	CLEAR VIEW



MODEL NO	RJ-6288
Description	CLEAR VIEW



OVER CASTING FOOT
(FLAT GUIDE)
(ONE STEP)

MODEL NO	RJ-7310B-G	MATERIAL	Zinc Alloy W/METAL
Description	FLAT GUIDE	MOQ	DEPENDS



MODEL NO	RJ-731LB-G
Description	FLAT GUIDE



MODEL NO	RJ-731SB-G
Description	FLAT GUIDE



MODEL NO	RJ-731HB-G
Description	FLAT GUIDE



OVER CASTING FOOT
(SLIVER GUIDE)
(ONE STEP)

MODEL NO	RJ-7310V
Description	SLIVER GUIDE
MATERIAL	Zinc Alloy W/METAL
MOQ	100 PCS



OVER CASTING FOOT
(SLIVER GUIDE)
(ONE STEP)

MODEL NO	RJ-7310-JK
Description	SLIVER GUIDE
MATERIAL	Zinc Alloy W/METAL
MOQ	100 PCS



OPEN TOE FOOT
(ONE STEP)

MODEL NO	RJ-7313	MATERIAL	ZINC ALLOY
Description	DEEP GROOVE	MOQ	100 PCS



MODEL NO	RJ-718L
Description	DEEP GROOVE



MODEL NO	RJ-718S
Description	DEEP GROOVE



MODEL NO	RJ-718H
Description	DEEP GROOVE



MADE IN TAIWAN SINCE 1951 NOW & FOREVER

THE SEWING MACHINE
SEWING FEET FACTORY



ONE STEP
Fits Our Shank adapter

Low shank : RJ-7300 / RJ-801 / RJ-803
RJ-7300J / RJ-7P00 / RJ-7J00
RJ-7N00 / RJ-7300N/RJ-7300NP
High shank : RJ-7300H / RJ-801H /
RJ-801H-BR / JS-001H

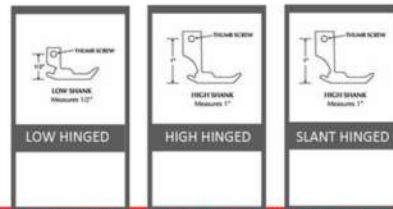

ALL SNAP ON (ONE STEP) SEWING FEET CAN BE MADE IN THE FOLLOWING TYPE

機
縫

台灣製造 一品質 服務客製化

7. WIDTH 7MM
MAX ZIG ZAG WIDTH 5MM



ROLLER FOOT
(ONE STEP)

MODEL NO	RJ-7314	MATERIAL	PLASTIC+METAL
Description	CLEAR VIEW	MOQ	100 PCS



MODEL NO	RJ-722L
Description	CLEAR VIEW



MODEL NO	RJ-722S
Description	CLEAR VIEW



MODEL NO	RJ-722H
Description	CLEAR VIEW



PIN TUCK FOOT
5-GROOVE
(ONE STEP)

MODEL NO	RJ-7315	MATERIAL	ZINC ALLOY
Description	5 GROOVE	MOQ	100 PCS



MODEL NO	RJ-732L
Description	5 GROOVE



MODEL NO	RJ-732S
Description	5 GROOVE



MODEL NO	RJ-732H
Description	5 GROOVE



ROLLER FOOT
(ONE STEP)
WHITE PLASTIC

MODEL NO	RJ-7314PW
Description	WHITE COLOR
MATERIAL	PLASTIC
MOQ	100 PCS



BRAIDING FOOT
W/BRAIDING GUIDE
(ONE STEP)

MODEL NO	RJ-7320(E)
Description	SET MODEL
MATERIAL	ZINC ALLOY + METAL
MOQ	300 SETS

* This set (RJ-7320(E)), will include a sewing foot and a braiding guide.
PACK : Zipper bag with sticker.



KNIT FOOT
(WALKING FOOT)
(ONE STEP)

MODEL NO	RJ-7316	MATERIAL	ZINC ALLOY + PLASTIC
Description	NON SLIP	MOQ	100



MODEL NO	RJ-733L
Description	NON SLIP



MODEL NO	RJ-733S
Description	NON SLIP



MODEL NO	RJ-733H
Description	NON SLIP



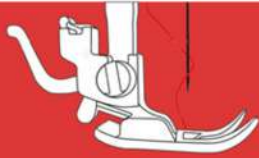

ONE STEP
Fits Our Shank adapter

Low shank : RJ-7300 / RJ-801 / RJ-803
RJ-7300J / RJ-7P00 / RJ-7100
RJ-7N00 / RJ-7300N/RJ-7300NP
High shank : RJ-7300H / RJ-801H /
RJ-801H-BR / JS-001H



ALL SNAP ON (ONE STEP) SEWING FEET CAN BE MADE IN THE FOLLOWING TYPE

機
縫

台灣製造 一品質 服務客製化

8. WIDTH 7MM
MAX ZIG ZAG WIDTH 5MM



FRINGE FOOT
(ONE STEP)

MODEL NO	RJ-7320FR
Description	3D LOOPING
MATERIAL	ZINC ALLOY + METAL
MOQ	100



BINDER FOOT
(ONE STEP)

MODEL NO	RJ-7329
Description	BINDER
MATERIAL	ZINC ALLOY + METAL
MOQ	100



EMBROIDERY FOOT
(ONE STEP)

MODEL NO	RJ-7323
Description	WITH EMBROIDERY FUNCTION

MATERIAL	ZINC ALLOY
MOQ	100 PCS



FOOT (LOW HINGED)

MODEL NO	RJ-734L
Description	WITH EMBROIDERY FUNCTION



FOOT (SLANT HINGED)

MODEL NO	RJ-734H
Description	WITH EMBROIDERY FUNCTION



FOOT (HIGH HINGED)

MODEL NO	RJ-734H
Description	WITH EMBROIDERY FUNCTION



4/8 INCH
ROLLER HEM FOOT
(ONE STEP)

MODEL NO	RJ-7327-4/8
Description	ROLLER HEM

MATERIAL	ZINC ALLOY + METAL
MOQ	100 PCS



FOOT (LOW HINGED)

MODEL NO	RJ-735L-4/8
Description	ROLLER HEM



FOOT (SLANT HINGED)

MODEL NO	RJ-735S-4/8
Description	ROLLER HEM



FOOT (HIGH HINGED)

MODEL NO	RJ-735H-4/8
Description	ROLLER HEM



6/8 INCH
ROLLER HEM FOOT
(ONE STEP)

MODEL NO	RJ-7327-6/8
Description	ROLLER HEM

MATERIAL	ZINC ALLOY + METAL
MOQ	100 PCS



FOOT (LOW HINGED)

MODEL NO	RJ-735L-6/8
Description	ROLLER HEM



FOOT (SLANT HINGED)

MODEL NO	RJ-735S-6/8
Description	ROLLER HEM



FOOT (HIGH HINGED)

MODEL NO	RJ-735H-6/8
Description	ROLLER HEM



8/8 INCH
ROLLER HEM FOOT
(ONE STEP)

MODEL NO	RJ-7327-8/8
Description	ROLLER HEM

MATERIAL	ZINC ALLOY + METAL
MOQ	100 PCS



FOOT (LOW HINGED)

MODEL NO	RJ-735L-8/8
Description	ROLLER HEM



FOOT (SLANT HINGED)

MODEL NO	RJ-735S-8/8
Description	ROLLER HEM



FOOT (HIGH HINGED)

MODEL NO	RJ-735H-8/8
Description	ROLLER HEM



RENJI

MADE IN TAIWAN



LOW SOLID

FITS MOST OF LOW SHANK SEWING MACHINES



機
縫

台灣製造 品質服務客製化

WIDTH 5 or 7MM
MAX ZIG ZAG WIDTH 5or7MM



MODEL NO	RJ-705L
Description	ORANGE SCREW
MATERIAL	METAL, PLASTIC
MOQ	100 PCS

STRAIGHT STITCH ONLY
ZIPPER/CORDING FOOT



MODEL NO	RJ-702
Description	SHIRRING
MATERIAL	ZINC ALLOY
MOQ	100 PCS

5MM MAX ZIG ZAG WIDTH
GATHERING FOOT



MODEL NO	RJ-705LM(I)
Description	ALL METAL
MATERIAL	ALL METAL
MOQ	100 PCS

STRAIGHT STITCH ONLY
ZIPPER/CORDING FOOT



MODEL NO	RJ-705LV
Description	W/INVISIBLE FUNCTION
MATERIAL	METAL, PLASTIC
MOQ	100 PCS

STRAIGHT STITCH ONLY
ADJUSTABLE INVLISBLE
ZIPPER/CORDING FOOT



MODEL NO	RJ-705LE
Description	CLEAR VIEW
MATERIAL	METAL, PLASTIC
MOQ	100 PCS

5MM MAX ZIG ZAG WIDTH
WELTING FOOT



MODEL NO	RJ-551
Description	3-WAY
MATERIAL	METAL, PLASTIC
MOQ	100 PCS

STRAIGHT STITCH ONLY
3-WAY
ZIPPER/CORDING FOOT

WHY YOU HAVE TO CHOSE RENJI'S INVISIBLE ZIPPER FOOT?

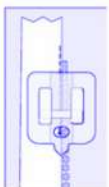

Applicable Products
RJ-601ZN ,
RJ-601ZPN
RJ-705LV

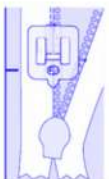

1. Clear view.

2. Automatic feed



Buy an invisible zipper that is at least 1 1/4" (3cm) longer than the zipper opening.

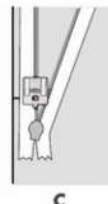

Automatic function
These two groove is important



MADE IN TAIWAN SINCE 1951 NOW & FOREVER

THE SEWING MACHINE
SEWING FEET FACTORY



LOW SOLID

FITS MOST OF LOW SHANK SEWING MACHINES



機
縫

台灣製造 一品質 服務客製化

10. WIDTH 5 or 7MM
MAX ZIG ZAG WIDTH 5or7M



MODEL NO	RJ-4010
Description	w yellow line
MATERIAL	METAL, PLASTIC
MOQ	100 PCS

MAX ZIG ZAG WIDTH 5MM
FREE MORION DARNING FOOT



MODEL NO	RJ-4021L-BP
Description	AGAINST FABRIC
MATERIAL	METAL, PLASTIC
MOQ	100 PCS

STRAIGHT STITCH ONLY
AGAINST THE FABRIC
DARNING FOOT



MODEL NO	RJ-4021P
Description	W RED LINE
MODEL NO	RJ-4021P-BR
Description	W RED LINE
MATERIAL	METAL, PLASTIC
MOQ	100 PCS

2 FUNCTION!
MAX ZIG ZAG WIDTH 7MM
FREE MORION DARNING FOOT



MODEL NO	RJ-4021P-OT
Description	OPEN TOE
MATERIAL	METAL, PLASTIC
MOQ	100 PCS

OPEN TOE
MAX ZIG ZAG WIDTH 7MM
FREE MORION DARNING FOOT



MODEL NO	RJ-4021L
Description	BASIC
MATERIAL	METAL, PLASTIC
MOQ	100 PCS

MAX ZIG ZAG WIDTH 7MM
DARNING FOOT



MODEL NO	RJ-4021L-OT
Description	OPEN TOE
MATERIAL	METAL + PLASTIC
MOQ	100 PCS

OPEN TOE
MAX ZIG ZAG WIDTH 7MM
DARNING FOOT



MODEL NO	RJ-4021LP
Description	BASIC
MATERIAL	METAL, PLASTIC
MOQ	100 PCS

MAX ZIG ZAG WIDTH 7MM
DARNING FOOT



MODEL NO	RJ-4021LP-OT
Description	OPEN TOE
MATERIAL	METAL, PLASTIC
MOQ	100 PCS

OPEN TOE
MAX ZIG ZAG WIDTH 7MM
DARNING FOOT



RENUYI

MADE IN TAIWAN



LOW SOLID

FITS MOST OF LOW SHANK SEWING MACHINES

機
縫

台灣製造 一品質 服務客製化

WIDTH 5 or 7MM
MAX ZIG ZAG WIDTH 5or7MM

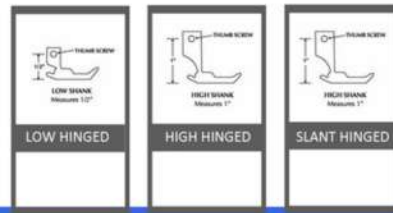

MODEL NO	5021L
Description	ORIGINAL
MODEL NO	5021L-1
Description	W/SCREW
MATERIAL	METAL, PLASTIC
MOQ	100 SETS

FLOWER STITCH ATTACHMENT



MODEL NO	RJ-CT01
Description	ORIGINAL
MODEL NO	RJ-CT01-1
Description	W/SCREW
MATERIAL	METAL, PLASTIC
MOQ	100 SETS

3-LAYERS FABRIC CUTTING!
SIDE CUTTER & HEM ATTACHMENT



MODEL NO	RJ-9000L
Description	ORIGINAL
MODEL NO	RJ-9000L-1
Description	W/SCREW
MATERIAL	METAL, PLASTIC
MOQ	100 SETS

SIDE CUTTER & HEM ATTACHMENT



MODEL NO	RJ-1895
Description	3D LOOPING
MATERIAL	METAL, PLASTIC ZINC ALLOY
MOQ	100 SETS

3D FRINGE FOOT

THE FOLLOWING SOLID PRODUCTS : RJ-29301~RJ-29307 HAVE TO ARRANGE WITH RJ-29309



MODEL NO	RJ-29309
Description	W/SCREW
MATERIAL	METAL, PLASTIC
MOQ	100 PCS

LOW SHANK ADAPTER



1/4 INCH ROLLER HEM FOOT
5MM MAX ZIG ZAG WIDTH

MODEL NO	RJ-29302
Description	ROLLER HEM
MODEL NO	RJ-29302+9
Description	WITH SHANK
MATERIAL	METAL
MOQ	100 PCS



3/8 INCH ROLLER HEM FOOT
5MM MAX ZIG ZAG WIDTH

MODEL NO	RJ-29303
Description	ROLLER HEM
MODEL NO	RJ-29303+9
Description	WITH SHANK
MATERIAL	METAL
MOQ	100 PCS



5/8 INCH ROLLER HEM FOOT
5MM MAX ZIG ZAG WIDTH

MODEL NO	RJ-29304
Description	ROLLER HEM
MODEL NO	RJ-29304+9
Description	WITH SHANK
MATERIAL	METAL
MOQ	100 PCS



7/8 INCH ROLLER HEM FOOT
5MM MAX ZIG ZAG WIDTH

MODEL NO	RJ-29305
Description	ROLLER HEM
MODEL NO	RJ-29305+9
Description	WITH SHANK
MATERIAL	METAL
MOQ	100 PCS



STITCH IN DITCH FOOT
5MM MAX ZIG ZAG WIDTH

MODEL NO	RJ-29306
Description	STITCH
MODEL NO	RJ-29306+9
Description	WITH SHANK
MATERIAL	METAL
MOQ	100 PCS



MADE IN TAIWAN SINCE 1951 NOW & FOREVER

TH

SEWING MACHINE
SEWING FEET FACTORY



LOW SOLID

FITS MOST OF LOW SHANK SEWING MACHINES



機
縫

台灣製造 一品質 服務客製化

12. WIDTH 5 or 7MM
MAX ZIG ZAG WIDTH 5or7M



5MM MAX ZIG ZAG WIDTH
BINDER FOOT

MODEL NO	RJ-29307
Description	BINDING
MODEL NO	RJ-29307+9
Description	WITH SHANK
MATERIAL	METAL
MOQ	100 PCS



FREE MOTION DARNING FOOT
5MM MAX ZIG ZAG WIDTH

MODEL NO	RJ-161876-1
Description	IMPORVED
MATERIAL	METAL, PLASTIC
MOQ	100 PCS



STRAIGHT STITCH ONLY
PIPING FOOT

MODEL NO	RJ-727L-1/4
Description	1/4 INCH
MODEL NO	RJ-727L-1/8
Description	1/8 INCH
MODEL NO	RJ-727L-3/16
Description	3/16 INCH
MATERIAL	ZINC ALLOY
MOQ	100 PCS



STITCH IN THE DITCH FOOT
5MM MAX ZIG ZAG WIDTH

MODEL NO	RJ-726L
Description	BLACK GUIDE
MATERIAL	ZINC ALLOY, METAL
MOQ	100 PCS



DARNING FOOT
7MM MAX ZIG ZAG WIDTH

MODEL NO	RJ-728L
Description	RED LINE
MATERIAL	PLASTIC
MOQ	100 PCS



ZIPPER / CORDING FOOT
STRAIGHT STITCH ONLY

MODEL NO	RJ-706L
Description	AGAINST THE FABRIC
MATERIAL	METAL
MOQ	100 PCS



DARNING FOOT
5MM MAX ZIG ZAG WIDTH

MODEL NO	RJ-701
Description	5MM
MATERIAL	METAL, PLASTIC
MOQ	100 PCS



DARNING FOOT
7MM MAX ZIG ZAG WIDTH

MODEL NO	RJ-701W
Description	7MM
MATERIAL	METAL, PLASTIC
MOQ	100 PCS



DARNING FOOT
5MM MAX ZIG ZAG WIDTH

MODEL NO	RJ-701M
Description	ALL METAL
MATERIAL	METAL
MOQ	100 PCS



DARNING FOOT
5MM MAX ZIG ZAG WIDTH

MODEL NO	RJ-161876
Description	5MM
MATERIAL	METAL, PLASTIC
MOQ	100 PCS



RENJI

MADE IN TAIWAN



LOW SOLID

FITS MOST OF LOW SHANK SEWING MACHINES

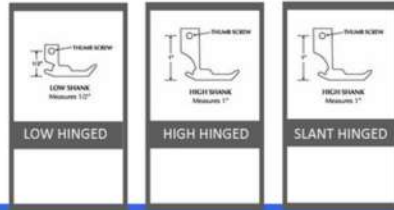

機
縫

台灣製造 品質 服務 客製化

13. WIDTH 5 or 7MM
MAX ZIG ZAG WIDTH 5or7M



QUILTING PIECING FOOT
STRAIGHT STITCH ONLY

MODEL NO	RJ-7322LQ4
Description	W/GUIDE
MATERIAL	METAL, ZINC ALLOY
MOQ	100 PCS
MODEL NO	RJ-7322LQ4-1
Description	W/GUIDE & SCREW



CLEAR
QUILTING PIECING FOOT
STRAIGHT STITCH ONLY

MODEL NO	RJ-7322LPQ4
Description	CLEAR VIEW
MATERIAL	METAL, ZINC ALLOY, PLASTIC
MOQ	100 PCS
MODEL NO	RJ-7322LPQ4-1
Description	W/GUIDE & SCREW



ADJUSTABLE RUFFLER
STRAIGHT STITCH ONLY

MODEL NO	55705
Description	1. 6. 12 ADJ.
MATERIAL	METAL, PLASTIC
MOQ	100 PCS
MODEL NO	55705-1
Description	W/SCREW



EVEN FEED WALKING FOOT
7MM MAX ZIG ZAG WIDTH

MODEL NO	RJ-600PW
Description	NO GUIDE
MODEL NO	RJ-600PWQ1
Description	W/GUIDE Q1
MODEL NO	RJ-600PWQ2
Description	W/GUIDE Q2
MODEL NO	RJ-600PWQ7
Description	W/GUIDE Q7

ADD -1 WILL INCLUDES SCREW



OPEN TOE
EVEN FEED WALKING FOOT
7MM MAX ZIG ZAG WIDTH
W 1/4, 1/8, 3/16 INCH QUILTING LINE

MODEL NO	RJ-600PW-OT
Description	NO GUIDE
MODEL NO	RJ-600PW-OTQ1
Description	W/GUIDE Q1
MODEL NO	RJ-600PW-OTQ2
Description	W/GUIDE Q2
MODEL NO	RJ-600PW-OTQ7
Description	W/GUIDE Q7

ADD -1 WILL INCLUDES SCREW



EVEN FEED WALKING FOOT
5MM MAX ZIG ZAG WIDTH

MODEL NO	RJ-600P
Description	NO GUIDE
MODEL NO	RJ-600PQ1
Description	W/GUIDE Q1
MATERIAL	RJ-600PQ7
MOQ	W/GUIDE Q7

ADD -1 WILL INCLUDES SCREW



EVEN FEED WALKING FOOT
5MM MAX ZIG ZAG WIDTH

MODEL NO	423242-451
Description	WITH FEED
MODEL NO	423242-451NT
Description	NO FEED
MATERIAL	METAL, PLASTIC
MOQ	100 PCS

ADD -1 WILL INCLUDES SCREW



EVEN FEED WALKING FOOT
5MM MAX ZIG ZAG WIDTH

MODEL NO	RJ-WA1
Description	ZINC ALLOY
MODEL NO	RJ-WA1-1
Description	W/SCREW
MATERIAL	ZINC ALLOY
MOQ	100 PCS

IN RENJI, YOU WILL SEE 2 DIFFERENT SCREW



RJ-SCR01
FOR RUFFLER, WALKING,
FLOWER STITCH, SIDE CUTTER, ETC.



RJ-SCR02
FOR HINGED SEWING FEET, SOLID SEWING FEET
ETC.



MADE IN TAIWAN SINCE 1951 NOW & FOREVER

TH

SEWING MACHINE
SEWING FEET FACTORY

RENUYI

MADE IN TAIWAN



LOW SOLID

FITS MOST OF LOW SHANK SEWING MACHINES

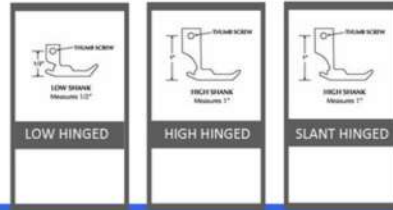

機縫

台灣製造 一品質 服務客製化

14. WIDTH 5 or 7MM
MAX ZIG ZAG WIDTH 5or7M



MODEL NO	RJ-7248L
Description	NO GUIDE
MODEL NO	RJ-7248LQ6
Description	W GUIDEQ6
MATERIAL	METAL, PLASTIC
MOQ	100 PCS

ADD (-1) WILL INCLUDES SCREW

EVEN FEED WALKING FOOT
7MM MAX ZIG ZAG WIDTH



MODEL NO	RJ-7248L-OT
Description	NO GUIDE
MODEL NO	RJ-7248L-OTQ6
Description	W/GUIDE
MATERIAL	METAL, PLASTIC
MOQ	100 PCS

ADD (-1) WILL INCLUDES SCREW

OPEN TOE
EVEN FEED WALKING FOOT
7MM MAX ZIG ZAG WIDTH



MODEL NO	RJ-7348L
Description	NO GUIDE
MATERIAL	METAL, PLASTIC
MOQ	100 PCS

ADD (-1) WILL INCLUDES SCREW

EVEN FEED WALKING FOOT
7MM MAX ZIG ZAG WIDTH



MODEL NO	RJ-7348L-OT
Description	NO GUIDE
MATERIAL	METAL, PLASTIC
MOQ	100 PCS

ADD (-1) WILL INCLUDES SCREW

OPEN TOE
WITH QUILTING RED LINE
EVEN FEED WALKING FOOT
7MM MAX ZIG ZAG WIDTH



MODEL NO	Z6000
Description	W/NEW BAR
MATERIAL	METAL
MOQ	100 SETS

ADD (-1) WILL INCLUDES SCREW
THIS Z6000 WILL CHANGE THE STRAIGHT STITCH BECOME ZIG ZAG FUNCTION (7 DIFFERENT FUNCTION)

ZIG ZAG ATTACHMENT
5MM MAX ZIG ZAG WIDTH



MODEL NO	RJ-BH-01
Description	IMPORVED
MATERIAL	METAL, PLASTIC
MOQ	100 PCS

THIS FOOT HAVE BEEN REPERSENTED IN JAPAN.

BUTTONHOLE ATTACHMENT

2015 THE QUILTING RULER FOOT NEW MADE IN TAIWAN ONLY
2016



MODEL NO	RJ-DN02	MODEL NO	RJ-DN02-OT	MODEL NO	RJ-DN02-DT
Description	REGULAR	Description	OPEN TOE	Description	SIDES
MATERIAL	ZINC ALLOY	MATERIAL	ZINC ALLOY	MATERIAL	ZINC ALLOY
MOQ	100 PCS	MOQ	100 PCS	MOQ	100 PCS





LOW SOLID

FITS MOST OF LOW SHANK SEWING MACHINES



LOW HINGED



HIGH HINGED



SLANT HINGED

機
縫

台灣製造 一品質 服務客製化

15. WIDTH 5 or 7MM
MAX ZIG ZAG WIDTH 5or7M



HEMMER FOOT
5MM MAX ZIG ZAG WIDTH

MODEL NO	RJ-717L
Description	REGULAR TYPE

MODEL NO	RJ-717LR
Description	ROUND HEM TYPE

MODEL NO	RJ-717LN
Description	AGAINST FABRIC TYPE

MATERIAL	ZINC ALLOY, METAL
MOQ	100 PCS



GATHERING/SHIRRING FOOT
STRAIGHT STITCH ONLY

MODEL NO	RJ-707R
Description	REGULAR

MATERIAL	METAL
MOQ	100 PCS



GATHERING/SHIRRING FOOT
STRAIGHT STITCH ONLY

MODEL NO	RJ-707
Description	REGULAR

MATERIAL	METAL
MOQ	100 PCS



BUTTON SEWING FOOT
5MM MAX ZIG ZAG WIDTH

MODEL NO	RJ-708
Description	GREEN PLASTIC

MATERIAL	METAL, PLASTIC
MOQ	100 PCS



GATHERING/SHIRRING FOOT
5MM MAX ZIG ZAG WIDTH

MODEL NO	RJ-714L
Description	REGULAR

MATERIAL	METAL
MOQ	100 PCS



ADJUSTABLE NON STICK
ZIPPER / CORDING FOOT
STRAIGHT STITCH ONLY

MODEL NO	RJ-6792
Description	ORANGE SCREW

MODEL NO	RJ-6792-1
Description	METAL SCREW

MATERIAL	METAL, PLASTIC
MOQ	100 PCS



ZIPPER / CORDING FOOT
STRAIGHT STITCH ONLY

MODEL NO	RJ-709
Description	RIGHT

MODEL NO	RJ-711
Description	LEFT

MATERIAL	METAL
MOQ	100 PCS

NEW! THE LOW SOLID WITH SUPER HIGH ADAPTER
(LOW HINGED SOLID ALSO AVAILABLE)
ARRANGE USE IT WITH RJ-809, RJ-811, RJ-813, RJ-815
(CHANGEABLE SUPER HIGH SHANK ADAPTER)



MODEL NO	55705-BN
Description	SUPER HIGH

MATERIAL	METAL
MOQ	100 SETS

DETAIL FOR RJ-809 -815, SEE PAGE 49 (THE SHANK ADAPTER)





LOW SOLID

FITS MOST OF LOW SHANK SEWING MACHINES



IMPROVED INDUSTRIAL TYPE
BECOME HOME TYPE.



機
縫

台灣製造 一品質 服務客製化

16. WIDTH 5 or 7MM
MAX ZIG ZAG WIDTH 5or7MM



MODEL NO	RJ-736L
Description	ADJUSTABLE
MATERIAL	STEEL
MOQ	100 PCS

IMPROVED INDUSTRIAL TYPE
BECOME HOME TYPE

ADJUSTABLE SHIRRING FOOT
STRAIGHT STITCH ONLY

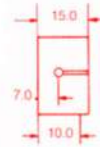

MODEL NO	RJ-737L
Description	JOINING TYPE
MATERIAL	STEEL
MOQ	100 PCS

IMPROVED INDUSTRIAL TYPE
BECOME HOME TYPE

PLY JOINING SHIRRING FOOT
STRAIGHT STITCH ONLY

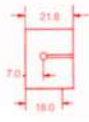

MODEL NO	RJ-737L-1
Description	JOINING TYPE
MATERIAL	STEEL
MOQ	100PCS

IMPROVED INDUSTRIAL TYPE
BECOME HOME TYPE

PLY JOINING SHIRRING FOOT
STRAIGHT STITCH ONLY



MODEL NO	RJ-738L
Description	REGULAR TYPE

SHIRRING FOOT
STRAIGHT STITCH ONLY
THE REGULAR TYPE
3 SIZE AVAILABLE

IMPROVED INDUSTRIAL TYPE
BECOME HOME TYPE



MODEL NO	RJ-738L-1
Description	REGULAR TYPE



MODEL NO	RJ-738L-2
Description	REGULAR TYPE



(MM)

	RJ-739L	RJ-739L-1	RJ-739L-2	RJ-739L-3
GROOVE WIDTH	2.0	3.0	2.0	4.0
GROOVE DEPTH	1.0	1.0	1.0	1.5

THICKNESS

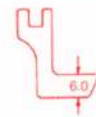
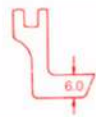

LEFT GROOVE PIPING FOOT
STRAIGHT STITCH ONLY

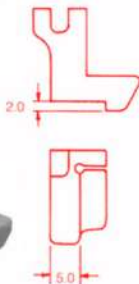

MODEL NO	RJ-739L-4
Description	CURVE
MATERIAL	STEEL
MOQ	100 PCS

LEFT GROOVE PIPING FOOT
STRAIGHT STITCH ONLY
FOR CURVES.



MODEL NO	RJ-740L
Description	RIGHT SIDE
MATERIAL	STEEL
MOQ	100 PCS

RIGHT SOLID RAISING FOOT
NEEDLE POINT TO GUIDE
1MM





MADE IN TAIWAN | SEWING DRESS FORM

With your logo printed on the SEWING DRESS FORM, we will charge you plate-making fee for the first time



8 pieces, 12 body dials
(4 each breast, waist, hips)
Neck dial adjustment.

MADE IN TAIWAN
2 SIZE AVAILABLE

DRESS FORM W/PIN CUSHION
RED COLOR / GARY COLOR
1. REGULAR BASE
2. ROLLER BASE



REGULAR BASE TYPE

MODEL NO	RJ-846486
Description	NO PIN CUSHION RED / GARY

Bust: 33 – 44 inches / 84 – 100 centimeters
Waist: 25 – 32 inches / 64 – 80 centimeters
Hips: 34 – 41 inches / 86 – 102 centimeters

MODEL NO	RJ-846486-1
Description	W/ PIN CUSHION RED / GARY

Bust: 33 – 41 inches / 84 – 104 centimeters
Waist: 25 – 33 inches / 64 – 84 centimeters
Hips: 36 – 44 inches / 91 – 112 centimeters

MODEL NO	RJ-107711
Description	NO PIN CUSHION RED / GARY

Bust: 40 – 46 inches / 100 – 116 centimeters
Waist: 31 – 37 inches / 77 – 93 centimeters
Hips: 40 – 46 inches / 101 – 117 centimeters

MODEL NO	RJ-107711-1
Description	W/ PIN CUSHION RED / GARY

Bust: 40 – 46 inches / 100 – 116 centimeters
Waist: 31 – 37 inches / 77 – 93 centimeters
Hips: 40 – 46 inches / 101 – 117 centimeters



ROLLER BASE TYPE

MODEL NO	RJ-846486R
Description	NO PIN CUSHION RED / GARY

Bust: 33 – 44 inches / 84 – 100 centimeters
Waist: 25 – 32 inches / 64 – 80 centimeters
Hips: 34 – 41 inches / 86 – 102 centimeters

MODEL NO	RJ-846486-1R
Description	W/ PIN CUSHION RED / GARY

Bust: 33 – 41 inches / 84 – 104 centimeters
Waist: 25 – 33 inches / 64 – 84 centimeters
Hips: 36 – 44 inches / 91 – 112 centimeters

MODEL NO	RJ-107711R
Description	NO PIN CUSHION RED / GARY

Bust: 40 – 46 inches / 100 – 116 centimeters
Waist: 31 – 37 inches / 77 – 93 centimeters
Hips: 40 – 46 inches / 101 – 117 centimeters

MODEL NO	RJ-107711-1R
Description	W/ PIN CUSHION RED / GARY

Bust: 40 – 46 inches / 100 – 116 centimeters
Waist: 31 – 37 inches / 77 – 93 centimeters
Hips: 40 – 46 inches / 101 – 117 centimeters

COLOR SHOW



DEEP RED

LIGHT RED

DEEP BLUE

GRAY COLOR

BLUE DOTS COLOR

OR YOU CAN COMBINE 4 COLOR IN 1 DRESS FORM



BACK AND FRONT SIDE

OR YOU CAN COMBINE 2 COLOR IN 1 DRESS FORM

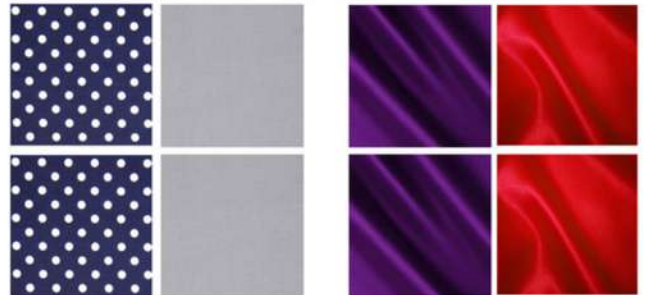



ONE STEP
Fits Our Shank adapter

Low shank : RJ-7300 / RJ-801 / RJ-803
 RJ-7300J / RJ-7P00 / RJ-7J00
 RJ-7N00 / RJ-7300N/RJ-7300NP
 High shank : RJ-7300H / RJ-801H /
 RJ-801H-BR / JS-001H



ALL SNAP ON (ONE STEP) SEWING FEET CAN BE MADE IN THE FOLLOWING TYPE

機
縫

台灣製造 一品質 服務 客製化



CLEAR INVISIBLE ZIPPER FOOT
STRAIGHT STITCH ONLY

MODEL NO	RJ-601
Description	REGULAR



← ONLY SNAP ON

MODEL NO	RJ-601N
Description	JUKI TYPE

MODEL NO	RJ-601L
Description	REGULAR

MODEL NO	RJ-601H
Description	REGULAR

MATERIAL	PLASTIC
MOQ	100 PCS



MODEL NO	RJ-601S
Description	REGULAR



GATHERING FOOT
STRAIGHT STITCH ONLY
USE SHANK : RJ-7300J

MODEL NO	RJ-6701-1
Description	1 PIN

MODEL NO	RJ-6701-2
Description	2 PINS

MATERIAL	ZINC ALLOY
MOQ	100 PCS



INVISIBLE ZIPPER FOOT
STRAIGHT STITCH ONLY
1. AGAINST THE FABRIC
2. AUTO-MATICALLY

MODEL NO	RJ-601ZE
Description	SPECIAL
MATERIAL	ZINC ALLOY
MOQ	100 PCS



THIS GROOVE IS IMPORTANT



INVISIBLE ZIPPER FOOT
STRAIGHT STITCH ONLY
REGULAR TYPE

MODEL NO	RJ-601Z
Description	REGULAR



MATERIAL	ZINC ALLOY
MOQ	100 PCS

MODEL NO	RJ-601LZ
Description	REGULAR

MODEL NO	RJ-601HZ
Description	REGULAR



MODEL NO	RJ-601SZ
Description	REGULAR



INVISIBLE ZIPPER FOOT
STRAIGHT STITCH ONLY
1. AGAINST THE FABRIC
2. AUTO-MATICALLY

MODEL NO	RJ-601ZN
Description	SPECIAL



MATERIAL	ZINC ALLOY
MOQ	100 PCS

MODEL NO	RJ-601LZN
Description	SPECIAL

MODEL NO	RJ-601HZN
Description	SPECIAL



MODEL NO	RJ-601SZN
Description	SPECIAL



THIS GROOVE IS IMPORTANT





ONE STEP
Fits Our Shank adapter

Low shank : RJ-7300 / RJ-801 / RJ-803
 RJ-7300J / RJ-7P00 / RJ-7J00
 RJ-7N00 / RJ-7300N/RJ-7300NP
 High shank : RJ-7300H / RJ-801H /
 RJ-801H-BR / JS-001H



ALL SNAP ON (ONE STEP) SEWING FEET CAN BE MADE IN THE FOLLOWING TYPE

機
縫

台灣製造 一品質 服務客製化



1/4, 1/8, 3/16 INCH
 CLEAR PATCHWORK FOOT
 STRAIGHT STITCH ONLY

MODEL NO	RJ-602	MODEL NO	RJ-602B	MODEL NO	RJ-602K	MATERIAL	PLASTIC
Description	RED LINE	Description	BLUE LINE	Description	BLACK LINE	MOQ	100 PCS

MODEL NO	RJ-602LZ	MODEL NO	RJ-602SZ
Description	RED LINE ZINC ALLOY SHANK	Description	RED LINE ZINC ALLOY SHANK

MODEL NO	RJ-602LP	MODEL NO	RJ-602SP
Description	RED LINE PLASTIC SHANK	Description	RED LINE PLASTIC SHANK

MODEL NO	RJ-602HZ	MODEL NO	RJ-602HP
Description	RED LINE ZINC ALLOY SHANK	Description	RED LINE PLASTIC SHANK



STRAIGHT STITCH FOOT
 REGULAR TYPE 14.9MM

MODEL NO	RJ-7304	MATERIAL	ZINC ALLOY	MODEL NO	RJ-7304R	MATERIAL	PLASTIC
Description	REGULAR	MOQ	100 PCS	Description	W/RED LINE	MOQ	100 PCS

MODEL NO	RJ-719L	MODEL NO	RJ-719S
Description	REGULAR	Description	REGULAR

MODEL NO	RJ-719LR	MODEL NO	RJ-719SR
Description	W/RED LINE	Description	W/RED LINE

MODEL NO	RJ-719H	MODEL NO	RJ-719HR
Description	REGULAR	Description	W/RED LINE



STRAIGHT STITCH FOOT
 REGULAR TYPE 16.9MM

MODEL NO	RJ-7304W-Y	MODEL NO	RJ-7304W-F
Description	REGULAR	Description	REGULAR

MODEL NO	RJ-7304WR-Y	MODEL NO	RJ-7304WR-F
Description	W/RED LINE	Description	W/RED LINE

MATERIAL	ZINC ALLOY	MATERIAL	ZINC ALLOY
MOQ	100 PCS	MOQ	100 PCS



STRAIGHT STITCH FOOT
 REGULAR TYPE 16.9MM



ZIPPER FOOT (2 SIDE)

MODEL NO	RJ-7306
Description	REGULAR
MATERIAL	ZINC ALLOY
MOQ	100 PCS



MASTER CURVE FOOT
 CLEAR 2 SIZE IN 1 TYPE

MODEL NO	RJ-6709
Description	2 SIZE IN 1
MATERIAL	PLASTIC
MOQ	100 PCS

ARRANGE THIS SEWING FOOT
 WITH ALL SHANK YOU HAVE
 E.G. HIGH SHANK, SLANT SHANK
 SP HIGH SHANK, LOW SHANK,
 ETC.



機 縫

RENUYI

MADE IN TAIWAN



ONE STEP Fits Our Shank adapter

Low shank : RJ-7300 / RJ-801 / RJ-803
 RJ-7300J / RJ-7P00 / RJ-7100
 RJ-7N00 / RJ-7300N/RJ-7300NP
 High shank : RJ-7300H / RJ-801H /
 RJ-801H-BR / JS-001H



ALL SNAP ON (ONE STEP) SEWING FEET CAN BE MADE IN THE FOLLOWING TYPE

2016 NEW

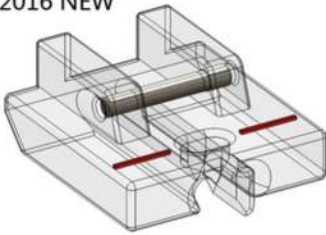

CLEAR W/QUILTING LINE INVISIBLE ZIPPER FOOT
 1. AGAINST THE FABRIC
 2. AUTO-MATICALLY

MODEL NO	RJ-601ZPN	MATERIAL	PLASTIC
Description	CLEAR	MOQ	100 PCS



MODEL NO	RJ-601LZPN
Description	CLEAR



MODEL NO	RJ-601SZPN
Description	CLEAR



MODEL NO	RJ-601HZPN
Description	CLEAR



THIS GROOVE IS IMPORTANT



CLEAR 1/4, 1/8, 3/16 INCH EDGE JOINING FOOT

MODEL NO	RJ-6710	MATERIAL	PLASTIC, METAL
Description	CLEAR	MOQ	300 PCS



MODEL NO	RJ-741L
Description	CLEAR



MODEL NO	RJ-741S
Description	CLEAR



MODEL NO	RJ-741H
Description	CLEAR



CLEAR STITCH IN THE DITCH FOOT

MODEL NO	RJ-6711	MATERIAL	PLASTIC, METAL
Description	CLEAR	MOQ	300 PCS



MODEL NO	RJ-742L
Description	CLEAR



MODEL NO	RJ-742S
Description	CLEAR



MODEL NO	RJ-742H
Description	CLEAR



QUILTING 1/4 INCH PIECING FOOT REGULAR

MODEL NO	RJ-7312	MATERIAL	ZINC ALLOY
Description	REGULAR	MOQ	100 PCS



MODEL NO	RJ-724L
Description	REGULAR



MODEL NO	RJ-724S
Description	REGULAR

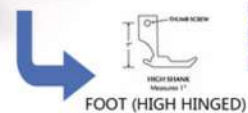

MODEL NO	RJ-724H
Description	REGULAR





ONE STEP
Fits Our Shank adapter

Low shank : RJ-7300 / RJ-801 / RJ-803
 RJ-7300J / RJ-7P00 / RJ-7100
 RJ-7N00 / RJ-7300N/RJ-7300NP
 High shank : RJ-7300H / RJ-801H /
 RJ-801H-BR / JS-001H



ALL SNAP ON (ONE STEP) SEWING FEET CAN BE MADE IN THE FOLLOWING TYPE

機
縫

台灣製造 一品質 服務客製化



1/4 INCH PIECING FOOT
STRAIGHT STITCH ONLY

MODEL NO	RJ-7312UK
Description	REGULAR P
MATERIAL	ZINC ALLOY
MOQ	100 PCS



ZIPPER/CORDING FOOT
ONE SIDE REGULAR

MODEL NO	RJ-7306-2
Description	COMPUTER
MATERIAL	ZINC ALLOY
MOQ	100 PCS



1/4 INCH PIECING FOOT
STRAIGHT STITCH ONLY

MODEL NO	RJ-7312U
Description	REGULAR
MATERIAL	ZINC ALLOY
MOQ	100 PCS



DOUBLE WELTING FOOT

MODEL NO	RJ-20808W-9IW
Description	DOUBLE WELTING
MATERIAL	ZINC ALLOY
MOQ	100 PCS



1/4 INCH PIECING FOOT
STRAIGHT STITCH ONLY

MODEL NO	RJ-7322	MATERIAL	ZINC ALLOY
Description	REGULAR	MOQ	100 PCS



MODEL NO	RJ-743L
Description	REGULAR

MODEL NO	RJ-743H
Description	REGULAR



MODEL NO	RJ-743S
Description	REGULAR

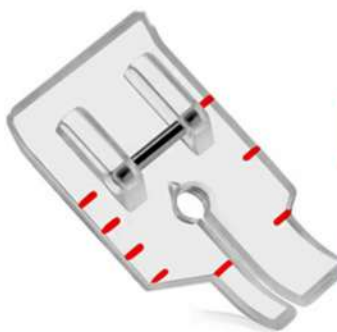

CLEAR
1/4 INCH PIECING FOOT
STRAIGHT STITCH ONLY

MODEL NO	RJ-7322P	MATERIAL	PLASTIC
Description	CLEAR	MOQ	100 PCS



MODEL NO	RJ-743LP
Description	REGULAR

MODEL NO	RJ-743HP
Description	REGULAR



MODEL NO	RJ-743SP
Description	REGULAR





ONE STEP
Fits Our Shank adapter

Low shank : RJ-7300 / RJ-801 / RJ-803
RJ-7300J / RJ-7P00 / RJ-7100
RJ-7N00 / RJ-7300N/RJ-7300NP
High shank : RJ-7300H / RJ-801H /
RJ-801H-BR / JS-001H



ALL SNAP ON (ONE STEP) SEWING FEET CAN BE MADE IN THE FOLLOWING TYPE

機
縫

台灣製造 品質服務客製化



1/4 INCH SEAM FOOT

MODEL NO	RJ-7321	MATERIAL	ZINC ALOY, METAL
Description	1/4 SEAM	MOQ	100 PCS



MODEL NO	RJ-744L
Description	1/4 SEAM



MODEL NO	RJ-744S
Description	1/4 SEAM

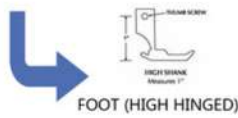

MODEL NO	RJ-744H
Description	1/4 SEAM



1/4 INCH SEAM FOOT
W/NEEDLE HOLE

MODEL NO	RJ-7321-1	MATERIAL	ZINC ALOY, METAL
Description	W/HOLE	MOQ	100 PCS



MODEL NO	RJ-744-1L
Description	W/HOLE



MODEL NO	RJ-744-1S
Description	W/HOLE



MODEL NO	RJ-744-1H
Description	W/HOLE



1/4 INCH EDGE JOINING FOOT

MODEL NO	RJ-7317	MATERIAL	ZINC ALOY, METAL
Description	REGULAR	MOQ	100 PCS



MODEL NO	RJ-745L
Description	REGULAR



RJ-745S
REGULAR



MODEL NO	RJ-745H
Description	REGULAR



1/4 INCH EDGE JOINING FOOT
2016 IMPROVED
1. DEEP NEEDLE HOLE
2. AGAINST THE FABRIC

MODEL NO	RJ-7317-DP	MODEL NO	RJ-7317R-DP	MATERIAL	ZINC ALOY, METAL
Description	DEEP HOLE	Description	W/RED LINE	MOQ	100 PCS



MODEL NO	RJ-745DP-L
Description	DEEP HOLE
MODEL NO	RJ-745DPR-L
Description	W/RED LINE



MODEL NO	RJ-745DP-S
Description	DEEP HOLE
MODEL NO	RJ-745DPR-S
Description	W/RED LINE

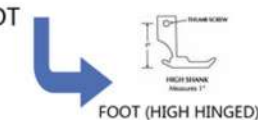

MODEL NO	RJ-745DP-H
Description	DEEP HOLE
MODEL NO	RJ-745DPR-H
Description	W/RED LINE





HIGH SOLID

FITS MOST OF HIGH SHANK SEWING MACHINES OR INDUSTRIAL DESIGN SEWING MACHINES



機
縫

台灣製造 一品質 服務客製化



ADJUSTABLE ZIPPER CORDING FOOT

MODEL NO	RJ-705H
Description	ORANGE SCREW
MATERIAL	METAL, PLASTIC
MOQ	100 PCS



ADJUSTABLE ZIPPER CORDING FOOT (ALL METAL)

MODEL NO	RJ-705HM
Description	METAL
MATERIAL	METAL
MOQ	100 PCS



ADJUSTABLE ZIPPER CORDING FOOT (3-WAY)

MODEL NO	RJ-552
Description	ORANGE SCREW
MODEL NO	RJ-552M
Description	METAL SCREW
MATERIAL	METAL, PLASTIC
MOQ	100 PCS



DARNING FOOT STRAIGHT STITCH ONLY

MODEL NO	RJ-728H
Description	CLEAR
MATERIAL	PLASTIC
MOQ	100 PCS



CLEAR FREE MOTION DARNING FOOT 7MM MAX ZIG ZAG WIDTH

MODEL NO	RJ-4021HP
Description	CLEAR
MATERIAL	METAL, PLASTIC
MOQ	100 PCS



CLEAR & OPEN TOE FREE MOTION DARNING FOOT 7MM MAX ZIG ZAG WIDTH

MODEL NO	RJ-4021HP-OT
Description	OPEN TOE
MATERIAL	METAL, PLASTIC
MOQ	100 PCS



EVEN FEED WALKING FOOT 5MM MAX ZIG ZAG WIDTH

MODEL NO	RJ-WA2
Description	5MM
MATERIAL	METAL, PLASTIC
MOQ	100 PCS
MODEL NO	RJ-WA2-1
Description	W/SCREW



EVEN FEED WALKING FOOT 5MM MAX ZIG ZAG WIDTH

MODEL NO	423242-451H
Description	HIGH SHANK
MODEL NO	423242-451H-1
Description	W/SCREW
MATERIAL	METAL, PLASTIC
MOQ	100 PCS





HIGH SOLID

FITS MOST OF HIGH SHANK SEWING MACHINES OR INDUSTRIAL DESIGN SEWING MACHINES



機
縫

台灣製造 品質 服務 客製化



MODEL NO	55642
Description	ADJUSTABLE
MATERIAL	METAL, PLASTIC
MOQ	100 PCS
MODEL NO	55642-1
Description	W/SCREW

ADJUSTABLE 1 6 12 RUFFLER



MODEL NO	RJ-4021I-BP
Description	AGAINST THE FABRIC
MATERIAL	METAL, PLASTIC
MOQ	100 PCS

FREE MOTION DARNING FOOT

1. HIGH SHANK (INDUSTRIAL DESIGN)
2. AGAINST THE FABRIC
3. CLEAR VIEW



MODEL NO	RJ-4021NH
Description	ALL METAL
MATERIAL	METAL
MOQ	50 PCS

FREE MOTION DARNING FOOT STRAIGHT STITCH ONLY



MODEL NO	RJ-DN01
Description	REGULAR
MODEL NO	RJ-DN01JN
Description	FOR J TYPE
MODEL NO	RJ-DN01OT
Description	OPEN TOE
MODEL NO	RJ-DN01DT
Description	SIDE

QUILTING RULER FOOT

1. HIGH SHANK
2. CAN BE USED ON LONG-ARM



MODEL NO	RJ-7248H
Description	NO GUIDE
MODEL NO	RJ-7248H-C
Description	WITH CLEAR GUIDE
MODEL NO	RJ-7248H-C-1
Description	WITH CLEAR GUIDE AND SCREW

THE HIGH SHANK EVEN FEED WALKING FOOT SET! (CLEAR QUILTING GUIDE)



MODEL NO	RJ-7248HA
Description	NO GUIDE
MODEL NO	RJ-7248HAQ
Description	WITH METAL GUIDE
MODEL NO	RJ-7248HAQ-1
Description	WITH METAL GUIDE AND SCREW

THE HIGH SHANK EVEN FEED WALKING FOOT SET! (METAL GUIDE)



MODEL NO	RJ-7248H-OT
Description	NO GUIDE
MODEL NO	RJ-7248H-C-OT
Description	WITH CLEAR GUIDE
MODEL NO	RJ-7248H-C-1-OT
Description	WITH CLEAR GUIDE AND SCREW

OPEN TOE THE HIGH SHANK EVEN FEED WALKING FOOT SET! (CLEAR QUILTING GUIDE)



MODEL NO	RJ-7248HA-OT
Description	NO GUIDE
MODEL NO	RJ-7248HAQ-OT
Description	WITH METAL GUIDE
MODEL NO	RJ-7248HAQ-1-OT
Description	WITH METAL GUIDE AND SCREW

OPEN TOE THE HIGH SHANK EVEN FEED WALKING FOOT SET! (METAL GUIDE)





HIGH SOLID

FITS MOST OF HIGH SHANK SEWING MACHINES OR INDUSTRIAL DESIGN SEWING MACHINES

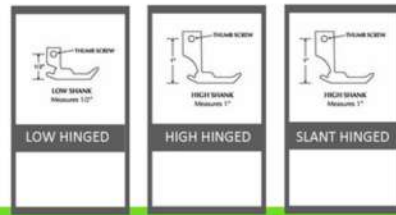

機
縫

台灣製造 品質 服務 客製化



MODEL NO	RJ-4021P-H
Description	SCREW ON
MATERIAL	METAL, PLASTIC
MOQ	100 PCS

HIGH SHANK FREE MOTION DARNING FOOT



MODEL NO	RJ-4021P-H-OT
Description	OPEN TOE
MATERIAL	METAL, PLASTIC
MOQ	100 PCS

HIGH SHANK, OPEN TOE FREE MOTION DARNING FOOT



MODEL NO	Z6000H
Description	HIGH SHANK
MATERIAL	METAL
MOQ	100 SETS

HIGH SHANK ZIG ZAG ATTACHMENT



MODEL NO	RJ-BH-02
Description	HIGH SHANK
MATERIAL	PLASTIC, METAL
MOQ	100 SETS

HIGH SHANK BUTTONHOLE ATTACHMENT



MODEL NO	RJ-DN03
Description	REGULAR
MODEL NO	RJ-DN03-OT
Description	OPEN TOE
MODEL NO	RJ-DN03-AT
Description	AGAINST THE FABRIC
MODEL NO	RJ-DN03-DP
Description	DEEP HOLE

LONG-ARM QUILTING RULER FOOT



MODEL NO	RJ-7D03
Description	STEEL
MATERIAL	STEEL
MOQ	100 PCS

SPRING GUIDE FOOT



MODEL NO	RJ-1895H
Description	HIGH SHANK
MATERIAL	ZINC ALLOY METAL
MOQ	100 PCS

LOOPING FOOT



MODEL NO	RJ-4021HPCG
Description	COUCHING
MATERIAL	METAL PLASTIC
MOQ	100 SETS

FREE MOTION COUCHING FOOT SET



MODEL NO	RJ-1896
Description	BLACK GUIDE
MATERIAL	ZINC ALLOY
MOQ	100 PCS

0.7MM STITCH IN THE DITCH FOOT



MODEL NO	RJ-1897
Description	TEFLON
MATERIAL	TEFLON
MOQ	100 PCS

TEFON FOOT





ONE STEP
Fits Our Shank adapter

Low shank : RJ-7300 / RJ-801 / RJ-803
 RJ-73001 / RJ-7P00 / RJ-7J00
 RJ-7N00 / RJ-7300N/RJ-7300NP
 High shank : RJ-7300H / RJ-801H /
 RJ-801H-8R / JS-001H

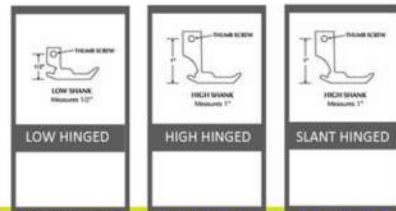

ALL SNAP ON (ONE STEP) SEWING FEET CAN BE MADE IN THE FOLLOWING TYPE

機
縫

台灣製造 一品質 服務客製化

26. WIDTH 9MM
MAX ZIG ZAG WIDTH 7MM



ZIG ZAG FOOT
(OLD TYPE)

MODEL NO	RJ-7301-2
Description	OLD TYPE

MATERIAL	ZINC ALLOY
MOQ	100 PCS



FOOT (LOW HINGED)

MODEL NO	RJ-746L
Description	OLD TYPE



FOOT (HIGH HINGED)

MODEL NO	RJ-746H
Description	OLD TYPE



FOOT (SLANT HINGED)

MODEL NO	RJ-746S
Description	OLD TYPE



ZIG ZAG FOOT
(NEW TYPE)

MODEL NO	RJ-7301-2J
Description	NEW TYPE

MATERIAL	ZINC ALLOY
MOQ	100 PCS



APPLIQUE FOOT

MODEL NO	RJ-607
Description	CLEAR

MATERIAL	PLASTIC
MOQ	100 PCS



ZIG ZAG FOOT

MODEL NO	RJ-7301W
Description	EURO TYPE

MATERIAL	ZINC ALLOY
MOQ	100 PCS



FOOT (LOW HINGED)

MODEL NO	RJ-720LW
Description	EURO TYPE



FOOT (HIGH HINGED)

MODEL NO	RJ-720HW
Description	EURO TYPE



FOOT (SLANT HINGED)

MODEL NO	RJ-720SW
Description	EURO TYPE



TEFLON ZIG ZAG FOOT

MODEL NO	RJ-7301T
Description	TEFLON

MATERIAL	PLASTIC, TEFLON
MOQ	100 PCS



FOOT (LOW HINGED)

MODEL NO	RJ-720LT
Description	TEFLON



FOOT (HIGH HINGED)

MODEL NO	RJ-720HT
Description	TEFLON



FOOT (SLANT HINGED)

MODEL NO	RJ-720ST
Description	TEFLON



PLASTIC ZIG ZAG FOOT

MODEL NO	RJ-7301PW
Description	PLASTIC

MATERIAL	PLASTIC
MOQ	100 PCS



FOOT (LOW HINGED)

MODEL NO	RJ-720LPW
Description	PLASTIC



FOOT (HIGH HINGED)

MODEL NO	RJ-720HPW
Description	PLASTIC



FOOT (SLANT HINGED)

MODEL NO	RJ-720SPW
Description	PLASTIC





ONE STEP
Fits Our Shank adapter

Low shank : RJ-7300 / RJ-801 / RJ-803
 RJ-7300J / RJ-7P00 / RJ-7100
 RJ-7N00 / RJ-7300N/RJ-7300NP
 High shank : RJ-7300H / RJ-801H /
 RJ-801H-8R / JS-001H

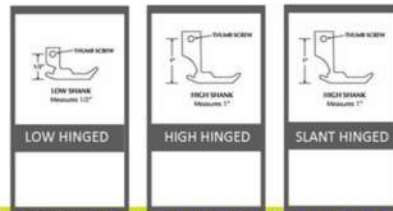

ALL SNAP ON (ONE STEP) SEWING FEET CAN BE MADE IN THE FOLLOWING TYPE

機
縫

台灣製造 品質服務客製化

27.
WIDTH 9MM
MAX ZIG ZAG WIDTH 7MM



CLEAR (LEFT SIDE)
ALL PURPOSE FOOT

MODEL NO	RJ-802R
Description	[R] MARK

MODEL NO	RJ-802J
Description	[J] MARK

MODEL NO	RJ-802-JR
Description	LONG TAIL

MATERIAL	ZINC ALLOY, PLASTIC, METAL
MOQ	100 PCS



CLEAR
ALL PURPOSE FOOT [SET]

MODEL NO	RJ-8012
Description	[SET LOW]

MODEL NO	RJ-8012H
Description	[SET HIGH]

MATERIAL	ZINC ALLOY, PLASTIC, METAL
MOQ	100 SETS



CLEAR (RIGHT SIDE)
ALL PURPOSE FOOT

MODEL NO	RJ-804
Description	[R] MARK

MATERIAL	ZINC ALLOY, PLASTIC, METAL
MOQ	100 PCS



CLEAR (RIGHT SIDE)
ALL PURPOSE FOOT [SET]

MODEL NO	RJ-8034
Description	[SET LOW]

MATERIAL	ZINC ALLOY, PLASTIC, METAL
MOQ	100 SETS



CLEAR
ALL PURPOSE FOOT

MODEL NO	RJ-806
Description	CLEAR

MATERIAL	ZINC ALLOY, PLASTIC, METAL
MOQ	100 PCS



CLEAR
CORDING/ALL PURPOSE FOOT

MODEL NO	RJ-808
Description	CLEAR

MATERIAL	ZINC ALLOY, PLASTIC, METAL
MOQ	100 SETS



CLEAR
SATIN STITCH (N) FOOT

MODEL NO	RJ-810
Description	CLEAR

MATERIAL	ZINC ALLOY, PLASTIC, METAL
MOQ	100 PCS



2mm HEMMING FOOT

MODEL NO	RJ-7307WR-2MMD
Description	2MM

MATERIAL	ZINC ALLOY
MOQ	100 PCS



SATIN STITCH / ZIG ZAG FOOT
(LONG TAIL)

MODEL NO	RJ-7301SSW
Description	LONG TAIL

MATERIAL	ZINC ALLOY
MOQ	100 PCS

Diagram	Diagram of a low hinged foot.
Foot (LOW HINGED)	

MODEL NO	RJ-720L-SSW
Description	LONG TAIL

Diagram	Diagram of a high hinged foot.
Foot (HIGH HINGED)	

MODEL NO	RJ-720H-SSW
Description	LONG TAIL

Diagram	Diagram of a slant hinged foot.
Foot (SLANT HINGED)	

MODEL NO	RJ-720S-SSW
Description	LONG TAIL





ONE STEP
Fits Our Shank adapter

Low shank : RJ-7300 / RJ-801 / RJ-803
 RJ-7300J / RJ-7PD0 / RJ-7100
 RJ-7N00 / RJ-7300N/RJ-7300NP
 High shank : RJ-7300H / RJ-801H /
 RJ-801H-8R / JS-001H

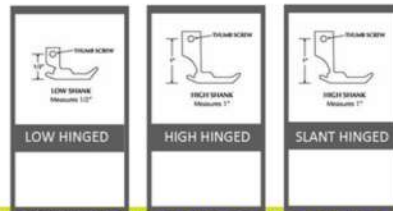

ALL SNAP ON (ONE STEP) SEWING FEET CAN BE MADE IN THE FOLLOWING TYPE

機
縫

台灣製造 品質服務客製化

28.
WIDTH 9MM
MAX ZIG ZAG WIDTH 7MM



ADJUSTABLE
GUIDE STITCHING FOOT

MODEL NO	RJ-6708
Description	ADJUSTABLE
MATERIAL	ZINC ALLOY, PLASTIC
MOQ	100 PCS



6 LINES
BOARDER GUIDE FOOT

MODEL NO	RJ-605
Description	6-LINES
MATERIAL	PLASTIC
MOQ	100 PCS

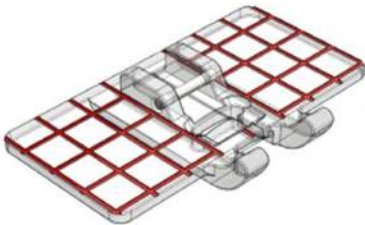

16 LINES
BOARDER GUIDE FOOT

MODEL NO	RJ-605W
Description	16-LINES
MATERIAL	PLASTIC
MOQ	100 PCS



3mm
ROUND HEMMING FOOT

MODEL NO	RJ-7307WR
Description	3MM
MATERIAL	ZINC ALLOY
MOQ	100 PCS



GUIDE STITCHING FOOT

MODEL NO	RJ-7319NR
Description	NO RED LINE
MATERIAL	ZINC ALLOY
MOQ	500 PCS



GUIDE STITCHING FOOT

MODEL NO	RJ-7319
Description	W/RED LINE
MATERIAL	ZINC ALLOY
MOQ	100 PCS



QUILTING OPEN TOE FOOT

MODEL NO	RJ-7313WR
Description	W/RED LINE
MATERIAL	ZINC ALLOY
MOQ	500 PCS



OPEN TOE [O] FOOT

MODEL NO	RJ-7313W
Description	[O] TYPE
MATERIAL	ZINC ALLOY
MOQ	100 PCS



STITCH IN THE DITCH FOOT
(SHORT GUIDE, BLACK COLOR)

MODEL NO	RJ-7318BR-1
Description	SHORT GUIDE
MATERIAL	ZINC ALLOY, METAL
MOQ	100 PCS
MODEL NO	RJ-7318BR-1R
Description	W/RED LINE



LONGER
STITCH IN THE DITCH FOOT

MODEL NO	RJ-7318BR
Description	LONG GUIDE
MATERIAL	ZINC ALLOY, METAL
MOQ	100 PCS
MODEL NO	RJ-7318BR-R
Description	W/RED LINE





ONE STEP
Fits Our Shank adapter

Low shank : RJ-7300 / RJ-801 / RJ-803
 RJ-73001 / RJ-7P00 / RJ-7100
 RJ-7N00 / RJ-7300N/RJ-7300NP
 High shank : RJ-7300H / RJ-801H /
 RJ-801H-8R / JS-001H

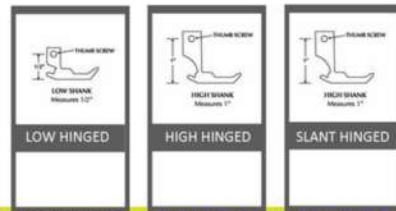

ALL SNAP ON (ONE STEP) SEWING FEET CAN BE MADE IN THE FOLLOWING TYPE

機
縫

台灣製造 一品質 服務客製化

29.
WIDTH 9MM
MAX ZIG ZAG WIDTH 7MM



MODEL NO	RJ-7324CR
Description	CLEAR
MATERIAL	SP Acrylic
MOQ	100 PCS

CLEAR
PEARLS & SEQUINS FOOT



MODEL NO	RJ-7330
Description	DEEP HOLE
MATERIAL	ZINC ALLOY
MOQ	100 PCS

DOUBLE PIPING FOOT



MODEL NO	RJ-7309WB-K
Description	100 PCS
MATERIAL	ZINC ALLOY, METAL
MOQ	100 PCS

3-HOLE
CORDING FOOT
(BLACK GUIDE [K])



MODEL NO	RJ-7313D
Description	DEEP HOLE
MATERIAL	ZINC ALLOY
MOQ	100 PCS

CANDLEWICKING FOOT



MODEL NO	RJ-7328
Description	DEEP HOLE
MATERIAL	ZINC ALLOY
MOQ	100 PCS

CHENILLE STITCHING FOOT



MODEL NO	RJ-7308W
Description	ADJUSTABLE
MATERIAL	ZINC ALLOY, PLASTIC
MOQ	100 PCS

BLIND STITCH FOOT



MODEL NO	RJ-7314W
Description	CLEAR
MATERIAL	METAL, PLASTIC
MOQ	100 PCS

CLEAR ROLLER FOOT



FOOT (LOW HINGED)

MODEL NO	RJ-722LW
Description	CLEAR



FOOT (SLANT HINGED)

MODEL NO	RJ-722SW
Description	CLEAR



FOOT (HIGH HINGED)

MODEL NO	RJ-722HW
Description	CLEAR



3-HOLE CORDING FOOT

MODEL NO	RJ-7309W
Description	3-HOLE
MATERIAL	ZINC ALLOY, METAL
MOQ	100 PCS



FOOT (LOW HINGED)

MODEL NO	RJ-716LW
Description	3-HOLE



FOOT (SLANT HINGED)

MODEL NO	RJ-716SW
Description	3-HOLW



FOOT (HIGH HINGED)

MODEL NO	RJ-716HW
Description	3-HOLE





ONE STEP
Fits Our Shank adapter

Low shank : RJ-7300 / RJ-801 / RJ-803
 RJ-73001 / RJ-7P00 / RJ-7100
 RJ-7N00 / RJ-7300N/RJ-7300NP
 High shank : RJ-7300H / RJ-801H /
 RJ-801H-8R / JS-001H

ALL SNAP ON (ONE STEP) SEWING FEET CAN BE MADE IN THE FOLLOWING TYPE

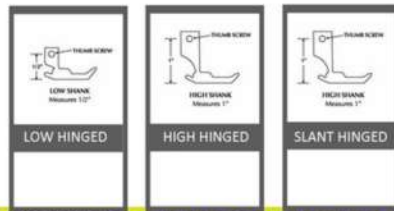

機
縫

台灣製造 品質服務客製化

10. WIDTH 9MM
MAX ZIG ZAG WIDTH 7MM



5/7 HOLE CORDING FOOT

MODEL NO	RJ-7309W-5
Description	5-HOLE
MATERIAL	ZINC ALLOY
MOQ	100 PCS
MODEL NO	RJ-7309W-7
Description	7-HOLE



ZIG ZAG DARING FOOT

MODEL NO	RJ-606
Description	ZIG ZAG
MATERIAL	PLASTIC
MOQ	100 PCS



OVERCASTING FOOT (E)

MODEL NO	RJ-7310BW-E
Description	E MARK
MATERIAL	ZINC ALLOY, PLASTIC
MOQ	100 PCS



SEQUINS & PEARLS FOOT

MODEL NO	RJ-7308WJ
Description	G MARK
MATERIAL	ZINC ALLOY, PLASTIC, METAL
MOQ	100 PCS



STITCH IN THE DITCH FOOT

MODEL NO	RJ-7325	MATERIAL	ZINC ALLOY, METAL
Description	BLACK GUIDE	MOQ	100 PCS



MODEL NO	RJ-746L
Description	BLACK GUIDE



MODEL NO	RJ-746S
Description	BLACK GUIDE



MODEL NO	RJ-746H
Description	BLACK GUIDE



STITCH IN THE DITCH FOOT

MODEL NO	RJ-7326	MATERIAL	ZINC ALLOY, METAL
Description	BLACK GUIDE	MOQ	100 PCS



MODEL NO	RJ-747L
Description	BLACK GUIDE



MODEL NO	RJ-747S
Description	BLACK GUIDE



MODEL NO	RJ-747H
Description	BLACK GUIDE



5-GROOVE
PIN TUCK FOOT (WIDE GROOVE)

MODEL NO	RJ-7315WBR
Description	5-GROOVE
MATERIAL	ZINC ALLOY
MOQ	100 PCS



7-GROOVE
PIN TUCK FOOT (ROUND GROOVE)

MODEL NO	RJ-6705
Description	7-GROOVE
MATERIAL	ZINC ALLOY
MOQ	100 PCS



RENUYI

MADE IN TAIWAN



ONE STEP
Fits Our Shank adapter

Low shank : RJ-7300 / RJ-801 / RJ-803
 RJ-73001 / RJ-7P00 / RJ-7100
 RJ-7N00 / RJ-7300N/RJ-7300NP
 High shank : RJ-7300H / RJ-801H /
 RJ-801H-8R / JS-001H

機
縫

台灣製造 一品質 服務客製化

WIDTH 9MM
MAX ZIG ZAG WIDTH 7MM

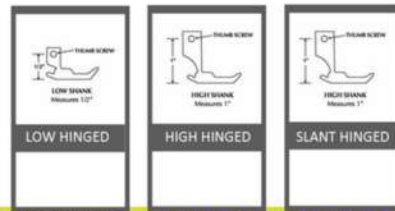

ALL SNAP ON (ONE STEP) SEWING FEET CAN BE MADE IN THE FOLLOWING TYPE



MODEL NO	RJ-7326JK
Description	SLIVER GUIDE
MATERIAL	ZINC ALLOY, METAL
MOQ	100 PCS

STITCH IN THE DITCH FOOT



MODEL NO	RJ-7326BR
Description	SLIVER GUIDE
MATERIAL	ZINC ALLOY, METAL
MOQ	100 PCS

BLIND STITCH FOOT



MODEL NO	RJ-7318
Description	SLIVER GUIDE
MATERIAL	ZINC ALLOY, METAL
MOQ	100 PCS

STITCH IN THE DITCH FOOT



MODEL NO	RJ-7307WR-4
Description	4MM
MATERIAL	ZINC ALLOY, METAL
MOQ	100 PCS

4MM HEMMING FOOT



MODEL NO	RJ-7307WR-6
Description	6MM
MATERIAL	ZINC ALLOY, METAL
MOQ	100 PCS

6MM HEMMING FOOT



MODEL NO	RJ-7315W-1
Description	NARROW
MATERIAL	ZINC ALLOY
MOQ	100 PCS

5-GROOVE
PIN TUCK FOOT (NARROW)



CLEAR
OPEN TOE FOOT

MODEL NO	P60794W
Description	CLEAR

MATERIAL	PLASTIC
MOQ	100 PCS



FOOT (LOW HINGED)



FOOT (HIGH HINGED)

MODEL NO	P60791
Description	CLEAR

MODEL NO	P60792
Description	CLEAR



FOOT (SLANT HINGED)

MODEL NO	P60793
Description	CLEAR



CLEAR
BUTTON SEWING FOOT

MODEL NO	RJ-7305W
Description	CLEAR

MATERIAL	PLASTIC
MOQ	100 PCS



FOOT (LOW HINGED)

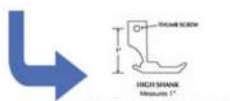

FOOT (HIGH HINGED)

MODEL NO	RJ-729LW
Description	CLEAR

MODEL NO	RJ-729HW
Description	CLEAR



FOOT (SLANT HINGED)

MODEL NO	RJ-729SW
Description	CLEAR



MADE IN TAIWAN SINCE 1951 NOW & FOREVER



SEWING MACHINE
SEWING FEET FACTORY



ONE STEP
Fits Our Shank adapter

Low shank : RJ-7300 / RJ-801 / RJ-803
 RJ-73001 / RJ-7P00 / RJ-7J00
 RJ-7N00 / RJ-7300N/RJ-7300NP
 High shank : RJ-7300H / RJ-801H /
 RJ-801H-BR / JS-001H

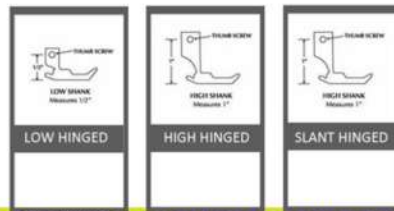

ALL SNAP ON (ONE STEP) SEWING FEET CAN BE MADE IN THE FOLLOWING TYPE

機
縫

台灣製造 品質服務客製化

WIDTH 9MM
MAX ZIG ZAG WIDTH 7MM



ALL PURPOSE A FOOT

MODEL NO	RJ-802A
Description	CLEAR VIEW
MATERIAL	METAL, ZINC AOOLY PLASTIC
MOQ	100 PCS



ALL PURPOSE A FOOT

MODEL NO	RJ-802A-F
Description	CLEAR VIEW
MATERIAL	METAL, ZINC AOOLY PLASTIC
MOQ	100 PCS



SEQUINS & PEARLS FOOT
1. CLEAR BLUE COLOR
2. CLEAR COLOR

MODEL NO	RJ-7324-B
Description	CLEAR BLUE



MODEL NO	RJ-7324-C
Description	CLEAR

MODEL NO	RJ-748L-B
Description	CLEAR BLUE

MODEL NO	RJ-748L-C
Description	CLEAR

MODEL NO	RJ-748H-B
Description	CLEAR BLUE

MODEL NO	RJ-748H-C
Description	CLEAR

MATERIAL	PLASTIC
MOQ	100 PCS



MODEL NO	RJ-748S-B
Description	CLEAR BLUE

MODEL NO	RJ-748S-C
Description	CLEAR



OVERCASTING FOOT

MODEL NO	RJ-7310BW
Description	BLACK GUIDE

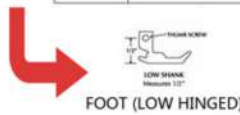

MATERIAL	ZINC ALLOY, METAL
MOQ	100 PCS

MODEL NO	RJ-731LBW-G
Description	BLACK GUIDE

MODEL NO	RJ-731HBW-G
Description	BLACK GUIDE



MODEL NO	RJ-731SBW-G
Description	BLACK GUIDE



9-GROOVE
PIN TUCK FOOT (WIDE)

MODEL NO	RJ-7315W
Description	9-GROOVE



MATERIAL	ZINC ALLOY
MOQ	100 PCS

MODEL NO	RJ-732LW
Description	9-GROOVE

MODEL NO	RJ-732HW
Description	9-GROOVE



MODEL NO	RJ-732SW
Description	9-GROOVE



EMBROIDERY FOOT CLEAR

MODEL NO	RJ-7303W
Description	CLEAR



MATERIAL	PC, METAL
MOQ	100 PCS

MODEL NO	RJ-721LW
Description	CLEAR

MODEL NO	RJ-721HW
Description	CLEAR



MODEL NO	RJ-721SW
Description	CLEAR



RENUYI

MADE IN TAIWAN



ONE STEP
Fits Our Shank adapter

Low shank : RJ-7300 / RJ-801 / RJ-803
 RJ-73001 / RJ-7P00 / RJ-7J00
 RJ-7N00 / RJ-7300N/RJ-7300NP
 High shank : RJ-7300H / RJ-801H /
 RJ-801H-8R / JS-001H

ALL SNAP ON (ONE STEP) SEWING FEET CAN BE MADE IN THE FOLLOWING TYPE

機
縫

台灣製造 品質服務客製化

WIDTH 9MM
MAX ZIG ZAG WIDTH 7MM

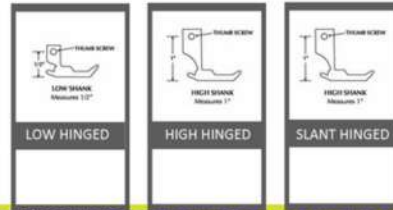

CLEAR
OPEN TOE EMBROIDERY FOOT

MODEL NO	RJ-7303W-OT
Description	OPEN TOE
MATERIAL	PLASTIC, METAL
MOQ	100 PCS



BLIND STITCH FOOT

MODEL NO	RJ-7326JW
Description	BLACK GUIDE
MATERIAL	ZINC ALLOY, METAL
MOQ	100 PCS



STITCH IN THE DITCH FOOT

MODEL NO	RJ-7326ST
Description	LEFT SIDE
MATERIAL	ZINC ALLOY, METAL
MOQ	100 PCS



5-GROOVE
PIN TUCK FOOT

MODEL NO	RJ-7315W-N
Description	5-GROOVE
MATERIAL	ZINC ALLOY
MOQ	100 PCS



7 GROOVE
PIN TUCK FOOT

MODEL NO	RJ-7315W-N2
Description	7-GROOVE
MATERIAL	ZINC ALLOY
MOQ	100 PCS



OVER EDGE JOINING FOOT

MODEL NO	A2
Description	W/BLUSH
MATERIAL	ZINCALLOY, PLASTIC METAL
MOQ	100 PCS



PEARLS FOOT (CLEAR) SET

MODEL NO	RJ-7324(E)
Description	CLEAR SET
MATERIAL	PLASTIC
MOQ	100 SETS



ADJUSTABLE STITCHING GUIDE FOOT

MODEL NO	RJ-7308W-ES
Description	ADJUSTABLE
MATERIAL	PLASTIC, ZINC ALLOY METAL
MOQ	100 PCS



ADJUSTABLE BINDING FOOT
(WIDE)

MODEL NO	RJ-6290W
Description	WIDE CLEAR



MATERIAL	PLASTIC, ZINC ALLOY METAL
MOQ	100 PCS

MODEL NO	RJ-6287W
Description	WIDE CLEAR



MODEL NO	RJ-6289W
Description	WIDE CLEAR



MODEL NO	RJ-6288W
Description	WIDE CLEAR



MADE IN TAIWAN SINCE 1951 NOW & FOREVER



SEWING MACHINE
SEWING FEET FACTORY



ONE STEP
Fits Our Shank adapter

Low shank : RJ-7300 / RJ-801 / RJ-803
 RJ-7300I / RJ-7P00 / RJ-7100
 RJ-7N00 / RJ-7300N/RJ-7300NP
 High shank : RJ-7300H / RJ-801H /
 RJ-801H-BR / JS-001H

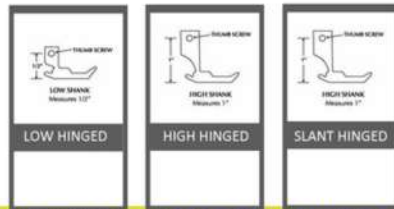

ALL SNAP ON (ONE STEP) SEWING FEET CAN BE MADE IN THE FOLLOWING TYPE

機
縫

台灣製造 一品質 服務客製化

34. WIDTH 9MM
MAX ZIG ZAG WIDTH 7MM



ROLLER HEM FOOT 4/8in.
(WIDE)

MODEL NO	RJ-7327W-4/8
Description	WIDE

MATERIAL	ZINC ALLOY, METAL
MOQ	100 PCS



FOOT (LOW HINGED)

MODEL NO	RJ-735LW-4/8
Description	WIDE



FOOT (HIGH HINGED)

MODEL NO	RJ-735HW-4/8
Description	WIDE



FOOT (SLANT HINGED)

MODEL NO	RJ-735SW-4/8
Description	WIDE



ROLLER HEM FOOT 6/8in.
(WIDE)

MODEL NO	RJ-7327W-6/8
Description	WIDE

MATERIAL	ZINC ALLOY, METAL
MOQ	100 PCS



FOOT (LOW HINGED)

MODEL NO	RJ-735LW-6/8
Description	WIDE



FOOT (HIGH HINGED)

MODEL NO	RJ-735HW-6/8
Description	WIDE



FOOT (SLANT HINGED)

MODEL NO	RJ-735SW-6/8
Description	WIDE



ROLLER HEM FOOT 8/8in.
(WIDE)

MODEL NO	RJ-7327W-8/8
Description	WIDE

MATERIAL	ZINC ALLOY, METAL
MOQ	100 PCS



FOOT (LOW HINGED)

MODEL NO	RJ-735LW-8/8
Description	WIDE



FOOT (HIGH HINGED)

MODEL NO	RJ-735HW-8/8
Description	WIDE



FOOT (SLANT HINGED)

MODEL NO	RJ-735SW-8/8
Description	WIDE



OVER CASTING FOOT

MODEL NO	A2M
Description	BLACK GUIDE
MATERIAL	ZINC ALLOY, METAL
MOQ	100 PCS



BINDER FOOT (WIDE)

MODEL NO	RJ-7329W
Description	WIDE
MATERIAL	ZINC ALLOY, METAL
MOQ	100 PCS



9mm SEAM FELLING FOOT

MODEL NO	RJ-7331
Description	9MM SEAM
MATERIAL	ZINC ALLOY
MOQ	300 PCS



SNAP ON RUFFLER

MODEL NO	55705-SP
Description	ADJUSTABLE
MATERIAL	ZINCALLOY, METAL
MOQ	100 SETS



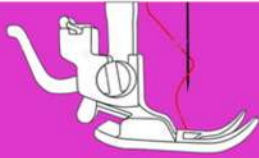

ONE STEP
Fits Our Shank adapter

Low shank : RJ-7300 / RJ-801 / RJ-803
 RJ-7300J / RJ-7P00 / RJ-7J00
 RJ-7N00 / RJ-7300N/RJ-7300NP
 High shank : RJ-7300H / RJ-801H /
 RJ-801H-BR / JS-001H



ALL SNAP ON (ONE STEP) SEWING FEET CAN BE MADE IN THE FOLLOWING TYPE

機
縫

台灣製造 一品質 服務客製化

35. WIDTH 11MM
MAX ZIG ZAG WIDTH 9MM

TIPS: BEFORE USE THESE SEWING FEET, PLEASE CHANGE THE FOLLOWING 2 PRODUCTS.



SHANK ADAPTER
FOR 9MM SNAP ON FEET

MODEL NO	RJ-7300W
Description	FOR 9MM
MATERIAL	ZINC ALLOY, METAL, PLASTIC
MOQ	100 PCS



SHANK ADAPTER
FOR SNAP ON WALKING FOOT

MODEL NO	RJ-7300WG
Description	FOR WALKING FOOT
MATERIAL	ZINC ALLOY, METAL, PLASTIC
MOQ	100 PCS



APPLIQUE FOOT (CLEAR)

MODEL NO	RJ-A9W9
Description	CLEAR
MATERIAL	PLASTIC
MOQ	100 PCS



NON STICK FOOT

MODEL NO	RJ-7301TW-9
Description	NON STICK
MATERIAL	PLASTIC
MOQ	100 PCS

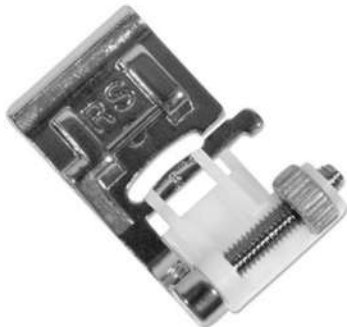

RIBBON & SEQUIN FOOT

MODEL NO	RJ-7308WJ-9G
Description	ADJUSTABLE
MATERIAL	ZINC ALLOY, PLASTIC
MOQ	100 PCS

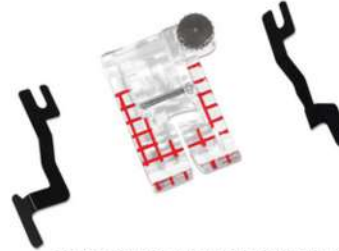

QUILTING GUIDE FOOT SET

MODEL NO	RJ-7322PE-9G
Description	WITH GUIDE
MATERIAL	METAL, PLASTIC
MOQ	100 PCS



3-HOLE CORDING FOOT

MODEL NO	RJ-7309W-9HM
Description	3-HOLE
MATERIAL	ZINC ALLOY, METAL
MOQ	100 PCS



7-GROOVE PIN TUCK FOOT

MODEL NO	RJ-7315W-1N9
Description	7-GROOVE
MATERIAL	ZINC ALLOY
MOQ	100 PCS

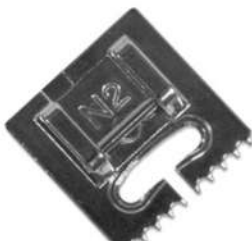

9-GROOVE PIN TUCK FOOT

MODEL NO	RJ-7315WR-2N9
Description	9-GROOVE
MATERIAL	ZINC ALLOY
MOQ	100 PCS

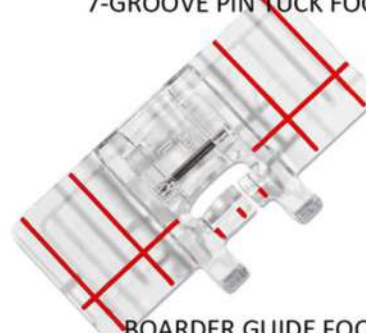

BOARDER GUIDE FOOT

MODEL NO	RJ-605W-9
Description	6 LINES
MATERIAL	PLASTIC
MOQ	100 PCS



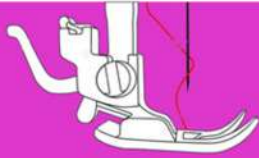

ONE STEP Fits Our Shank adapter

Low shank : RJ-7300 / RJ-801 / RJ-803
 RJ-7300J / RJ-7P00 / RJ-7J00
 RJ-7N00 / RJ-7300N/RJ-7300NP
 High shank : RJ-7300H / RJ-801H /
 RJ-801H-BR / JS-001H



ALL SNAP ON (ONE STEP) SEWING FEET CAN BE MADE IN THE FOLLOWING TYPE

機
縫

台灣製造 一品質 服務客製化

36. WIDTH 11MM
MAX ZIG ZAG WIDTH 9MM

TIPS: BEFORE USE THESE SEWING FEET, PLEASE CHANGE THE FOLLOWING 2 PRODUCTS.



SHANK ADAPTER FOR 9MM SNAP ON FEET

MODEL NO	RJ-7300W
Description	FOR 9MM
MATERIAL	ZINC ALLOY, METAL, PLASTIC
MOQ	100 PCS



FREE MOTION QUILTING FOOT SNAP ON (CLOSED AND OPEN TOE)

MODEL NO	RJ-7334
Description	CLOSED
MATERIAL	plastic
MOQ	100 PCS
MODEL NO	RJ-7334-OT
Description	OPEN TOE



ADJUSTABLE RUFFLER SNAP ON

MODEL NO	55705SW-9M
Description	ADJUSTABLE
MATERIAL	ZINC ALLOY, METAL
MOQ	100 PCS



STRAIGHT STITCH FOOT

MODEL NO	RJ-7304W-TS9
Description	STRAIGHT
MATERIAL	ZINC ALLOY
MOQ	100 PCS



ADJUSTABLE GUIDE STITCH FOOT

MODEL NO	RJ-7308WR-9ES
Description	ADJUSTABLE
MATERIAL	ZINC ALLOY, PLASTIC
MOQ	100 PCS



SATIN STITCH FOOT

MODEL NO	RJ-7303WJ-9IS
Description	CLEAR
MATERIAL	PLASTIC METAL
MOQ	100 PCS



GATHERING FOOT

MODEL NO	RJ-20309-9V
Description	2 PIN
MATERIAL	ZINC ALLOY
MOQ	100 PCS



OVERCASTING FOOT

MODEL NO	A2W-M9
Description	BLACK GUIDE
MATERIAL	ZINC ALLOY METAL
MOQ	100 PCS



DOUBLE PIPING FOOT

MODEL NO	RJ-20808W-9IW
Description	DOUBLE SIDE
MATERIAL	ZINC ALLOY
MOQ	100 PCS



STITCH IN THE DITCH FOOT

MODEL NO	RJ-7326ST9-K2
Description	BLACK GUIDE
MATERIAL	ZINC ALLOY, METAL
MOQ	100 PCS





ONE STEP
Fits Our Shank adapter

Low shank : RJ-7300 / RJ-801 / RJ-803
 RJ-7300J / RJ-7P00 / RJ-7100
 RJ-7N00 / RJ-7300N/RJ-7300NP
 High shank : RJ-7300H / RJ-801H /
 RJ-801H-BR / JS-001H

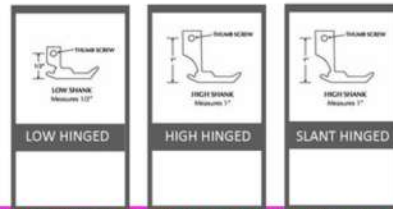

ALL SNAP ON (ONE STEP) SEWING FEET CAN BE MADE IN THE FOLLOWING TYPE

機
縫

台灣製造 一品質 服務客製化

57. WIDTH 11MM
MAX ZIG ZAG WIDTH 9MM

TIPS: BEFORE USE THESE SEWING FEET, PLEASE CHANGE THE FOLLOWING 2 PRODUCTS.



SHANK ADAPTER
FOR 9MM SNAP ON FEET

MODEL NO	RJ-7300W FOR 9MM
Description	
MATERIAL	ZINC ALLOY, METAL, PLASTIC
MOQ	100 PCS



SHANK ADAPTER
FOR SNAP ON WALKING FOOT

MODEL NO	RJ-7300WG FOR WALKING FOOT
Description	
MATERIAL	ZINC ALLOY, METAL, PLASTIC
MOQ	100 PCS



4MM HEMMING FOOT

MODEL NO	RJ-7307WR-4MM9D
Description	4MM
MATERIAL	ZINC ALLOY, METAL
MOQ	100 PCS



6MM HEMMING FOOT

MODEL NO	RJ-7307WR-6MM9D
Description	6MM
MATERIAL	ZINC ALLOY, METAL
MOQ	100 PCS



BINDER FOOT

MODEL NO	RJ-7329W-9W BINDER
Description	
MATERIAL	ZINC ALLOY, METAL
MOQ	100 PCS



BEADING FOOT CLEAR

MODEL NO	RJ-7324WR-9MW UP TO 2MM
Description	
MATERIAL	PLASTIC
MOQ	100 PCS



BEADING FOOT CLEAR
NARROW TYPE

MODEL NO	RJ-7324W-9MW NARROW TYPE
Description	
MATERIAL	PLASTIC
MOQ	100 PCS



RED ARROW
SATIN STITCH FOOT

MODEL NO	RJ-7303W-TE9 W/RED ARROW
Description	
MATERIAL	PLASTIC, METAL
MOQ	100 PCS



BLIND STITCH FOOT

MODEL NO	RJ-7326JW-N9 BLACK GUIDE
Description	
MATERIAL	ZINC ALLOY, METAL
MOQ	100 PCS



ZIPPER/CORDING FOOT

MODEL NO	RJ-7306-2EW-9 ONE SIDE
Description	
MATERIAL	ZINC ALLOY
MOQ	100 PCS



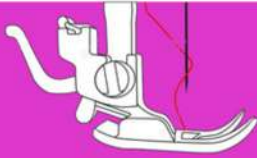

ONE STEP
Fits Our Shank adapter

Low shank : RJ-7300 / RJ-801 / RJ-803
 RJ-7300J / RJ-7P00 / RJ-7J00
 RJ-7N00 / RJ-7300N/RJ-7300NP
 High shank : RJ-7300H / RJ-801H /
 RJ-801H-BR / JS-001H

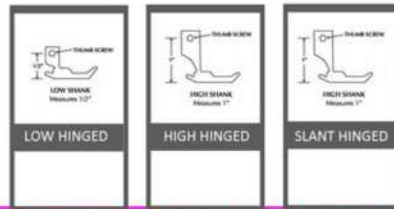

ALL SNAP ON (ONE STEP) SEWING FEET CAN BE MADE IN THE FOLLOWING TYPE

機
縫

台灣製造 一品質 服務客製化

38. WIDTH 11MM
MAX ZIG ZAG WIDTH 9MM

TIPS: BEFORE USE THESE SEWING FEET, PLEASE CHANGE THE FOLLOWING 2 PRODUCTS.



SHANK ADAPTER
FOR 9MM SNAP ON FEET

MODEL NO	RJ-7300W FOR 9MM
Description	
MATERIAL	ZINC ALLOY, METAL, PLASTIC
MOQ	100 PCS



SHANK ADAPTER
FOR SNAP ON WALKING FOOT

MODEL NO	RJ-7300WG FOR WALKING FOOT
Description	
MATERIAL	ZINC ALLOY, METAL, PLASTIC
MOQ	100 PCS



INVISIBLE ZIPPER FOOT

MODEL NO	RJ-601ZNW-9Z
Description	AUTO MATICALLY
MATERIAL	ZINC ALLOY
MOQ	100 PCS



THIS GROOVE IS IMPORTANT



2MM HEMMING FOOT

MODEL NO	RJ-7307WR-2MM9D
Description	2MM
MATERIAL	ZINC ALLOY, METAL
MOQ	100 PCS



BUTTON SEWING FOOT (CLEAR)

MODEL NO	RJ-7305W-T9 CLEAR
Description	
MATERIAL	PLASTIC
MOQ	100 PCS



1/4 INCH SEAM FOOT

MODEL NO	RJ-7321W-09
Description	BLACK GUIDE
MATERIAL	ZINC ALLOY, METAL
MOQ	100 PCS



REGULAR
SNAP ON WALKING FOOT

MODEL NO	RJ-6716 REGULAR
Description	
MATERIAL	METAL
MOQ	100 PCS



OPEN TOE
SNAP ON WALKING FOOT

MODEL NO	RJ-6714 OPEN TOE
Description	
MATERIAL	METAL
MOQ	100 PCS



STITCH IN THE DITCH
SNAP ON WALKING FOOT

MODEL NO	RJ-6712 BLACK GUIDE
Description	
MATERIAL	METAL
MOQ	100 PCS



1/4 INCH SEAM FOOT
SNAP ON WALKING FOOT

MODEL NO	RJ-6713 1/4 SEAM
Description	
MATERIAL	METAL
MOQ	100 PCS



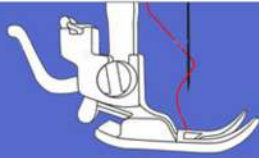

ONE STEP
Fits Our Shank adapter

Low shank : 155964
SLANT SHANK : 542167



LOW HINGED



SLANT HINGED

機
縫

台灣製造 一品質 服務客製化

TIPS: SHANK (LOW = ONLY 155964, SLANT = ONLY 542167)



(SET) STRAIGHT STITCH, ZIG ZAG
AND 155964 SHANK KIT.

MODEL NO	446014
Description	LOW TYPE
MATERIAL	ZINC ALLOY, METAL
MOQ	100 SETS



13MM STRAIGHT STITCH FOOT

MODEL NO	RJ-713
Description	13MM
MATERIAL	ZINC ALLOY, METAL
MOQ	100 PCS



EDGE JOINING FOOT

MODEL NO	RJ-725L
Description	BLACK GUIDE
MATERIAL	ZINC ALLOY, METAL
MOQ	100 SETS



7 GROOVE PIN TUCK FOOT

MODEL NO	S701L
Description	7-GROOVE
MATERIAL	ZINC ALLOY
MOQ	100 PCS



12MM STRAIGHT STITCH FOOT

MODEL NO	RJ-712
Description	12MM
MATERIAL	ZINC ALLOY, METAL
MOQ	100 SETS



OPEN TOE FOOT (CLEAR)

MODEL NO	P60777
Description	OPEN TOE
MATERIAL	PLASTIC
MOQ	100 PCS



SATIN STITCH FOOT (CLEAR)

MODEL NO	446492-451
Description	CLEAR
MATERIAL	PLASTIC
MOQ	100 PCS



FLAT HEMMING FOOT 3MM

MODEL NO	P55607
Description	3MM
MATERIAL	ZINC ALLOY
MOQ	100 PCS



ZIG ZAG B FOOT

MODEL NO	446371
Description	B TYPE
MATERIAL	ZINC ALLOY
MOQ	100 PCS



REGULAR ZIG ZAG FOOT

MODEL NO	155962
Description	REGULAR
MATERIAL	ZINC ALLOY
MOQ	100 PCS

LOW SNAP ON AND LOW HINGED FOR OLD TYPE 6MM
PLEASE USE 155964 FOR THESE SEWING FEET



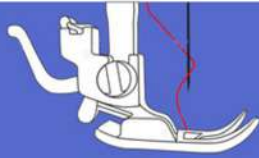

ONE STEP
Fits Our Shank adapter

Low shank : 155964
SLANT SHANK : 542167



LOW HINGED



SLANT HINGED

機
縫

台灣製造 一品質 服務客製化

TIPS: SHANK (LOW = ONLY 155964, SLANT = ONLY 542167)



OVER LOCK FOOT

MODEL NO	161956
Description	REGULAR
MATERIAL	ZINC ALLOY
MOQ	100 PCS



STRAIGHT STITCH FOOT

MODEL NO	153267
Description	STRAIGHT
MATERIAL	ZINC ALLOY
MOQ	100 PCS



BUTTONHOLE SEWING FOOT

MODEL NO	161927
Description	CLEAR
MATERIAL	PLASTIC
MOQ	100 PCS



WHITE PLASTIC
BUTTON SEWING FOOT

MODEL NO	RJ-750L
Description	WHITE COLOR
MATERIAL	PLASTIC
MOQ	100 PCS



ZIPPER/CORDING FOOT

MODEL NO	507836
Description	2 SIDES
MATERIAL	METAL, PLASTIC
MOQ	100 PCS



OVERCASTING FOOT

MODEL NO	255L
Description	SLIVER GUIDE
MATERIAL	ZINC ALLOY, METAL
MOQ	100 PCS

LOW SNAP ON AND LOW HINGED FOR OLD TYPE 6MM
PLEASE USE 155964 FOR THESE SEWING FEET



SLANT OPEN TOE FOOT (CLEAR)

MODEL NO	P60778
Description	CLEAR
MATERIAL	PLASTIC
MOQ	100 PCS



SLANT OVER LOCK FOOT

MODEL NO	384119-451
Description	SLANT
MATERIAL	ZINC ALLOY
MOQ	100 PCS



SLANT ZIG ZAG FOOT

MODEL NO	172075
Description	SLANT
MATERIAL	ZINC ALLOY, METAL
MOQ	100 PCS



SLANT OVERCASTING FOOT

MODEL NO	255S
Description	SLANT
MATERIAL	ZINC ALLOY, METAL
MOQ	100 PCS



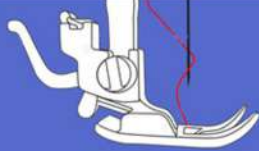

ONE STEP
Fits Our Shank adapter

Low shank : 155964
SLANT SHANK : 542167



LOW HINGED



SLANT HINGED

機
縫

台灣製造 一品質 服務客製化

TIPS: SHANK (LOW = ONLY 155964, SLANT = ONLY 542167)



3-WAY
SLANT ZIPPER/CORDING FOOT

MODEL NO	RJ-553
Description	3 WAY
MATERIAL	ZINC ALLOY, METAL, PLASTIC
MOQ	100 PCS



SLANT HEMMING FOOT

MODEL NO	5012-1
Description	3MM
MATERIAL	ZINC ALLOY, METAL
MOQ	100 PCS



SLANT
ZIPPER/CORDING FOOT CLEAR

MODEL NO	171480
Description	CLEAR
MATERIAL	METAL, PLASTIC
MOQ	100 PCS



SLANT STRAIGHT STITCH FOOT

MODEL NO	170071
Description	SLANT D
MATERIAL	ZINC ALLOY, METAL
MOQ	100 PCS



SLANT D STRAIGHT STITCH FOOT

MODEL NO	409377
Description	D FOOT
MATERIAL	ZINC ALLOY
MOQ	100 PCS



SLANT ZIPPER/CORDING FOOT

MODEL NO	RJ-706S
Description	(161166)
MATERIAL	ZINC ALLOY, METAL
MOQ	100 PCS



SLANT WALKING FOOT

MODEL NO	421333-451
Description	REGULAR
MATERIAL	METAL, PLASTIC
MOQ	100 PCS



SLANT ADJUSTABLE RUFFLER

MODEL NO	55642S
Description	ADJUSTABLE
MATERIAL	METAL, PLASTIC
MOQ	100 PCS

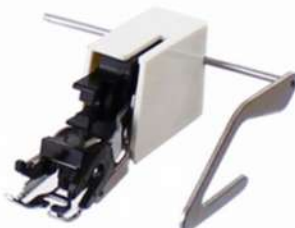

SLANT WALKING FOOT
WITH QUILTING GUIDE

MODEL NO	421333-451Q1
Description	W/GUIDE
MATERIAL	PLASTIC, METAL
MOQ	300 SETS



SLANT B ZIG ZAG FOOT

MODEL NO	313150
Description	B TYPE
MATERIAL	ZINC ALLOY
MOQ	100 PCS





ONE STEP
Fits Our Shank adapter
OVER LOCK & COVER STITCH

FOR HOME OVERLOCK/COVER STITCH **NOT FOR INDUSTRIAL**

機
縫

台灣製造 一品質 服務客製化



ELASTIC STITCHING FOOT
(WIDE: 9-13.5MM)

MODEL NO	RJ-6777
Description	FOR COVER STITCH O TYPE
MATERIAL	ZINC ALLOY, METAL, PLASTIC
MOQ	100 PCS



ELASTIC STITCHING FOOT
(NARROW: 6-8.5MM)

MODEL NO	RJ-6778
Description	FOR COVER STITCH O TYPE
MATERIAL	ZINC ALLOY, METAL, PLASTIC
MOQ	100 PCS



CLEAR VIEW 3 NEEDLES
COVER STITCH FOOT

MODEL NO	RJ-6779
Description	FOR COVER STITCH O TYPE
MATERIAL	ZINC ALLOY, METAL, PLASTIC
MOQ	100 PCS



CLEAR VIEW 2 NEEDLES
COVER STITCH FOOT

MODEL NO	RJ-6779-1
Description	FOR COVER STITCH O TYPE
MATERIAL	ZINC ALLOY, METAL, PLASTIC
MOQ	100 PCS



CORDING FOOT (A)

MODEL NO	RJ-6780
Description	FOR COVER STITCH O TYPE
MATERIAL	ZINC ALLOY, METAL, PLASTIC
MOQ	100 PCS



STANDARD FOOT

MODEL NO	RJ-6786
Description	FOR COVER STITCH O TYPE
MATERIAL	ZINC ALLOY, METAL, PLASTIC
MOQ	100 PCS



CENTER GUIDE 3 NEEDLES FOOT

MODEL NO	RJ-6784
Description	FOR COVER STITCH O TYPE
MATERIAL	ZINC ALLOY, METAL, PLASTIC
MOQ	100 PCS



CENTER GUIDE 2 NEEDLES FOOT

MODEL NO	RJ-6784-1
Description	FOR COVER STITCH O TYPE
MATERIAL	ZINC ALLOY, METAL, PLASTIC
MOQ	100 PCS



3/16 INCH PIPING FOOT

MODEL NO	RJ-6783
Description	FOR OVER LOCK O TYPE
MATERIAL	ZINC ALLOY, METAL, PLASTIC
MOQ	100 PCS



1/8 INCH PIPING FOOT

MODEL NO	RJ-6782
Description	FOR OVER LOCK O TYPE
MATERIAL	ZINC ALLOY, METAL, PLASTIC
MOQ	100 PCS



RENJYI

MADE IN TAIWAN



ONE STEP
Fits Our Shank adapter
OVER LOCK & COVER STITCH

FOR HOME OVERLOCK/COVER STITCH **NOT FOR INDUSTRIAL**

機
縫

台灣製造 一品質 服務客製化

43. OVER LOCK & COVER STITCH
MADE IN TAIWAN



CORDING FOOT

MODEL NO	RJ-6770
Description	FOR OVER LOCK O TYPE
MATERIAL	ZINC ALLOY, METAL, PLASTIC
MOQ	100 PCS



PIN TUCK CORDING GUIDE SET

MODEL NO	RJ-6787
Description	FOR COVER STITCH O TYPE
MATERIAL	ZINC ALLOY, METAL, PLASTIC
MOQ	100 SETS



RIBBON AND TAPE SEWING SET

MODEL NO	RJ-6771
Description	FOR COVER STITCH O TYPE
MATERIAL	ZINC ALLOY, METAL, PLASTIC
MOQ	100 SETS



ROLLER FOOT

MODEL NO	RJ-67723
Description	FOR OVER LOCK O TYPE
MATERIAL	ZINC ALLOY, METAL, PLASTIC
MOQ	100 SETS



ELASTIC STITCHING FOOT

MODEL NO	RJ-6776
Description	FOR COVER STITCH O TYPE
MATERIAL	ZINC ALLOY, METAL, PLASTIC
MOQ	100 SETS



BLIND HEM (STITCHING) FOOT

MODEL NO	RJ-6775
Description	FOR OVER LOCK O TYPE
MATERIAL	ZINC ALLOY, METAL, PLASTIC
MOQ	100 SETS



CIRCULAR SEWING ATTACHMENT

MODEL NO	RJ-OC009
Description	UNIVERSAL
MATERIAL	METAL, PLASTIC
MOQ	100 PCS



CIRCULAR SEWING ATTACHMENT

MODEL NO	RJ-OC010
Description	UNIVERSAL
MATERIAL	METAL, PLASTIC
MOQ	100 PCS



MADE IN TAIWAN SINCE 1951 NOW & FOREVER

THE SEWING MACHINE
SEWING FEET FACTORY



ONE STEP
Fits Our Shank adapter
OVER LOCK & COVER STITCH

FOR HOME OVERLOCK/COVER STITCH **NOT FOR INDUSTRIAL**

機
縫

台灣製造 一品質 服務客製化



CLEAR
CORDING FOOT SET

MODEL NO	RJ-603
Description	N TYPE FOR COVER STITCH
MATERIAL	PLASTIC
MOQ	100 SETS



CLEAR
COVER HEM FOOT SET

MODEL NO	RJ-603-2
Description	N TYPE FOR COVER STITCH
MATERIAL	PLASTIC
MOQ	100 SETS



CLEAR FLAT LACE FOOT SET

MODEL NO	RJ-603-3
Description	N TYPE FOR COVER STITCH
MATERIAL	PLASTIC
MOQ	100 SETS



CLEAR
BIAS TAPE BINDING FOOT

MODEL NO	RJ-603-4
Description	N TYPE FOR COVER STITCH
MATERIAL	PLASTIC
MOQ	100 SETS



CLEAR HEMMING FOOT

MODEL NO	RJ-603-5
Description	N TYPE FOR COVER STITCH
MATERIAL	PLASTIC
MOQ	100 SETS



CLEAR
BIAS TAPE FOLDER FOOT SET

MODEL NO	RJ-603-6
Description	N TYPE FOR COVER STITCH
MATERIAL	PLASTIC
MOQ	100 SETS



CLEAR
FLAT EDGE LACE FOOT SET

MODEL NO	RJ-603-7
Description	N TYPE FOR COVER STITCH
MATERIAL	PLASTIC
MOQ	100 SETS



7 PCS IN 1 PACK
CLEAR COVER STITCH FOOT SET

MODEL NO	RJ-6370
Description	N TYPE FOR COVER STITCH
MATERIAL	PLASTIC
MOQ	100 SETS



LACE APPLICATION FOOT

MODEL NO	RJ-608
Description	N TYPE FOR OVER LOCKER
MATERIAL	ZINC ALLOY, METAL
MOQ	100 PCS



QUILTING CORDING FOOT

MODEL NO	RJ-608-3
Description	N TYPE FOR OVER LOCKER
MATERIAL	ZINC ALLOY, METAL
MOQ	100 PCS



YARN APPLICATION FOOT

MODEL NO	RJ-608-2
Description	N TYPE FOR OVER LOCKER
MATERIAL	ZINC ALLOY, METAL
MOQ	100 PCS





ONE STEP
Fits Our Shank adapter
OVER LOCK & COVER STITCH

FOR HOME OVERLOCK/COVER STITCH **NOT FOR INDUSTRIAL**

機
縫

台灣製造 品質服務客製化



GATHERING/SHIRRING FOOT

MODEL NO	RJ-608-4
Description	N TYPE FOR OVER LOCKER
MATERIAL	ZINC ALLOY, METAL
MOQ	100 PCS



ELASTIC FOOT

MODEL NO	RJ-608-5
Description	N TYPE FOR OVER LOCKER
MATERIAL	ZINC ALLOY, METAL
MOQ	100 PCS



CORDING FOOT

MODEL NO	RJ-608-6
Description	N TYPE FOR OVER LOCKER
MATERIAL	ZINC ALLOY, METAL
MOQ	100 PCS



BEADING FOOT

MODEL NO	RJ-608-6
Description	N TYPE FOR OVER LOCKER
MATERIAL	ZINC ALLOY, METAL
MOQ	100 PCS



6 PCS OVERLOCKER FEET SET

MODEL NO	RJ-608-8
Description	N TYPE FOR OVER LOCKER
MATERIAL	ZINC ALLOY, METAL
MOQ	100 PCS

MODEL NO	RJ-6086
Description	N TYPE FOR OVER LOCKER
MATERIAL	ZINC ALLOY, METAL
MOQ	100 SETS



BELT LOOP FOOT

MODEL NO	RJ-6788
Description	FOR COVER STITCH O TYPE
MATERIAL	PLASTIC
MOQ	100 PCS



STANDARD FOOT

MODEL NO	RJ-9979
Description	N & E & L TYPE OVER LOCKER
MATERIAL	ZINC ALLOY, METAL
MOQ	100 PCS



BLIND HEM FOOT

MODEL NO	RJ-9980
Description	N & E & L TYPE OVER LOCKER
MATERIAL	ZINC ALLOY, METAL
MOQ	100 PCS



ELASTIC FOOT

MODEL NO	RJ-9981
Description	N & E & L TYPE OVER LOCKER
MATERIAL	ZINC ALLOY, METAL
MOQ	100 PCS



RENUYI

MADE IN TAIWAN



ONE STEP
Fits Our Shank adapter
OVER LOCK & COVER STITCH

FOR HOME OVERLOCK/COVER STITCH **NOT FOR INDUSTRIAL**

機
縫

台灣製造 一品質 服務客製化

46. OVER LOCK & COVER STITCH
MADE IN TAIWAN



BEADING/SEQUIN FOOT

MODEL NO	RJ-9983
Description	N & E & L TYPE OVER LOCKER
MATERIAL	ZINC ALLOY, METAL
MOQ	100 PCS



CORDING/PIPING FOOT

MODEL NO	RJ-9984
Description	N & E & L TYPE OVER LOCKER
MATERIAL	ZINC ALLOY, METAL
MOQ	100 PCS



TAPING FOOT

MODEL NO	RJ-9985
Description	N & E & L TYPE OVER LOCKER
MATERIAL	ZINC ALLOY, METAL
MOQ	100 PCS



SHIRRING/GATHERING FOOT

MODEL NO	RJ-9982
Description	N & E & L TYPE OVER LOCKER
MATERIAL	ZINC ALLOY, METAL
MOQ	100 PCS



6 PCS OPTIONAL FEET SET

MODEL NO	RJ-9986 (E)
Description	N & E & L TYPE OVER LOCKER
MATERIAL	ZINC ALLOY, METAL
MOQ	100 PCS



5 PCS OPTIONAL FEET BOX

MODEL NO	RJ-9950
Description	N TYPE OVER LOCKER
MATERIAL	ZINC ALLOY, METAL
MOQ	100 PCS



THE FEED DOG

MODEL NO	RJ-77015
Description	U TYPE OVER LOCKER
MATERIAL	ZINC ALLOY
MOQ	100 PCS



THE FEED DOG

MODEL NO	RJ-77016
Description	U TYPE OVER LOCKER
MATERIAL	ZINC ALLOY
MOQ	100 PCS



STANDARD FOOT

MODEL NO	RJ-77007
Description	U TYPE OVER LOCKER
MATERIAL	ZINC ALLOY
MOQ	100 PCS



0.5MM BLIND HEM FOOT

MODEL NO	RJ-77022
Description	U TYPE OVER LOCKER
MATERIAL	ZINC ALLOY
MOQ	100 PCS



MADE IN TAIWAN SINCE 1951 NOW & FOREVER

THE SEWING MACHINE
SEWING FEET FACTORY



ONE STEP
Fits Our Shank adapter
OVER LOCK & COVER STITCH

FOR HOME OVERLOCK/COVER STITCH **NOT FOR INDUSTRIAL**

機
縫

台灣製造 一品質 服務客製化



1.0 mm BLIND HEM FOOT

MODEL NO	RJ-77023
Description	U TYPE OVER LOCKER
MATERIAL	ZINC ALLOY, METAL
MOQ	100 PCS



ELASTIC FOOT

MODEL NO	RJ-77027
Description	U TYPE OVER LOCKER
MATERIAL	ZINC ALLOY, METAL
MOQ	100 PCS



SHIRRING/GATHERING FOOT

MODEL NO	RJ-77059
Description	U TYPE OVER LOCKER
MATERIAL	ZINC ALLOY, METAL
MOQ	100 PCS



BEADING/SEQUIN FOOT

MODEL NO	RJ-77080
Description	U TYPE OVER LOCKER
MATERIAL	ZINC ALLOY, METAL
MOQ	100 PCS



ELASTIC FOOT

MODEL NO	SF-X51-OOA
Description	U B TYPE OVER LOCKER
MATERIAL	ZINC ALLOY, METAL
MOQ	100 PCS



CORDING FEET HINGED

MODEL NO	RJ-609
Description	N TYPE OVER LOCKER
MATERIAL	ZINC ALLOY, METAL
MOQ	100 PCS



ELASTIC FOOT (REGULAR)

MODEL NO	RJ-60570
Description	REGULAR TYPE OVER LOCKER
MATERIAL	ZINC ALLOY, METAL
MOQ	100 PCS



ADJUSTABLE CORDING FOOT

MODEL NO	RJ-610
Description	B & B TYPE OVER LOCKER
MATERIAL	ZINC ALLOY, METAL
MOQ	100 PCS

TIPS

Add versatility to your OVERLOCKER/COVER STITCH sewing machine with a new presser foot. Presser feet are designed for activities such as gathering and rolled hem, buttonholes, zippers and cording, blind hem and open toe, zig zag and more.

Choose OVERLOCKER/COVER STITCH presser feet by category from the sections IN OUR CATALOG. To save time in finding presser feet for your specific machine, Or you can give us a MAIL! We have the knowledge and expertise that comes with over 45 years in PRODUCING SEWING EET. We'll be happy to help select the proper feet for your machine.



機 縫

RENUYI

MADE IN TAIWAN

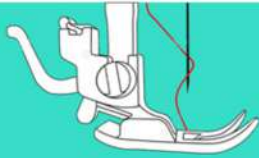

ONE STEP

USE THESE SHANK FOR

1. MIDDLE NEEDLE POSITION SP FEET
2. LEFT NEEDLE POSITION SP FEET
3. SUPER HIGH SHANK SP FEET
4. SUPER HIGH LEVEL SP FEET

SP = SNAP ON (ONE STEP)



LOW HINGED



HIGH HINGED



SLANT HINGED

ALL SNAP ON (ONE STEP) SEWING FEET CAN BE MADE IN THE FOLLOWING TYPE



LOW SHANK TYPE
(Not reflective SERIES)

MODEL NO	RJ-7P00
Description	NO REFLECTIVE
MATERIAL	ZINC ALLOY, METAL
MOQ	100 PCS
MODEL NO	RJ-7P00Q11F
Description	WITH QUILTING GUIDE



LOW SHANK TYPE
(REGULAR FOR 5MM SERIES)

MODEL NO	RJ-7300
Description	REGULAR

MODEL NO	RJ-7300B
Description	BLACK GUIDE

MODEL NO	RJ-7300BR
Description	BLACK GUIDE W/NO REFLECTIVE STICKER

MATERIAL	ZINC ALLOY, METAL
MOQ	100 PCS

MODEL NO	RJ-7300Q11
Description	WITH QUILTING GUIDE



HIGH SHANK TYPE
(INDUSTRIAL DESIGN SERIES)

MODEL NO	RJ-7300H
Description	REGULAR

MODEL NO	RJ-7300Q7
Description	WITH QUILTING GUIDE

MATERIAL	ZINC ALLOY, METAL
MOQ	100 PCS



LOW SHANK TYPE
(REGULAR FOR 7MM SERIES)

MODEL NO	RJ-801
Description	REGULAR

MODEL NO	RJ-801Q2
Description	WITH QUILTING GUIDE

MATERIAL	ZINC ALLOY, METAL, PLASTIC
MOQ	100 PCS



HIGH SHANK TYPE
(INDUSTRIAL DESIGN SERIES)

MODEL NO	RJ-801H
Description	REGULAR

MODEL NO	RJ-801HQ7
Description	WITH QUILTING GUIDE

MATERIAL	ZINC ALLOY, METAL
MOQ	100 PCS



LOW SHANK TYPE
(REGULAR FOR 7MM SERIES)

MODEL NO	RJ-803
Description	REGULAR

MODEL NO	RJ-803Q2
Description	WITH QUILTING GUIDE

MATERIAL	ZINC ALLOY, METAL, PLASTIC
MOQ	100 PCS



LOW SHANK TYPE
(REGULAR TYPE FOR 7MM SEWING FEET)

MODEL NO	RJ-807
Description	REGULAR

MODEL NO	RJ-805Q11N
Description	WITH QUILTING GUIDE

MATERIAL	ZINC ALLOY, METAL
MOQ	100 PCS



HIGH SHANK TYPE
(HOME+INDUSTRIAL DESIGN SERIES)

MODEL NO	RJ-801H-BR
Description	REGULAR

MODEL NO	RJ-801H-BRQ7
Description	WITH QUILTING GUIDE

MATERIAL	ZINC ALLOY, METAL, PLASTIC
MOQ	100 PCS

TIPS THESE SHANK ADAPTER ARE FOR [REGULAR]



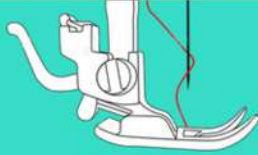

ONE STEP

USE THESE SHANK FOR

1. MIDDLE NEEDLE POSITION SP FEET
 2. LEFT NEEDLE POSITION SP FEET
 3. SUPER HIGH SHANK SP FEET
 4. SUPER HIGH LEVEL SP FEET
- SP = SNAP ON (ONE STEP)

ALL SNAP ON (ONE STEP) SEWING FEET CAN BE MADE IN THE FOLLOWING TYPE

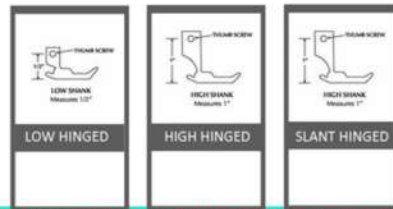

機
縫

台灣製造 一品質 服務客製化



HIGH LEVEL TYPE
OLD TYPE SHANK ADAPTER

MODEL NO	RJ-809
Description	OLD TYPE
MATERIAL	ZINC ALLOY
MOQ	100 SETS



HIGH LEVEL TYPE
NEW TYPE SHANK ADAPTER

MODEL NO	RJ-811
Description	NEW TYPE
MATERIAL	ZINC ALLOY
MOQ	100 SETS



HIGH LEVEL TYPE
OLD TYPE SHANK ADAPTER

MODEL NO	RJ-815
Description	OLD TYPE
MATERIAL	ZINC ALLOY
MOQ	100 SETS



HIGH LEVEL TYPE
NEW TYPE SHANK ADAPTER

MODEL NO	RJ-813
Description	NEW TYPE
MATERIAL	ZINC ALLOY
MOQ	100 SETS



QUILTING GUIDE
(FOR HINGED FEET)

MODEL NO	RJ-Q03
Description	ALL METAL
MATERIAL	METAL
MOQ	100 PCS



QUILTING GUIDE
(FOR HINGED FEET)

MODEL NO	RJ-Q04
Description	ALL METAL
MATERIAL	METAL
MOQ	100 PCS



QUILTING GUIDE
(FOR BRAIDING FEET)

MODEL NO	RJ-Q05
Description	ALL METAL
MATERIAL	METAL
MOQ	500 PCS



QUILTING GUIDE
(FOR BRAIDING FEET)

MODEL NO	RJ-Q05-2
Description	ALL METAL
MATERIAL	METAL
MOQ	1000 PCS



QUILTING GUIDE
1. FOR WALKING FOOT
2. FOR SHANK ADAPTER

MODEL NO	RJ-Q01
Description	FOR WALKING FOOT
MODEL NO	RJ-Q02
Description	FOR WALKING FOOT FOR SHANK
MODEL NO	RJ-Q07
Description	FOR WALKING FOOT FOR SHANK
MATERIAL	METAL
MOQ	300 PCS



QUILTING GUIDE
(FOR SHANK ADAPTER)

MODEL NO	RJ-7311
Description	REGULAR
MODEL NO	RJ-7311F
Description	NO FL TYPE
MODEL NO	RJ-7311N
Description	FOR REGULAR FOR LEFE NEEDLE
MATERIAL	METAL
MOQ	600 PCS



機 縫

RENUYI

MADE IN TAIWAN

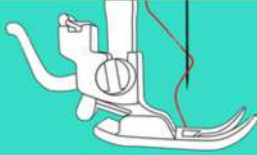

ONE STEP

USE THESE SHANK FOR

1. MIDDLE NEEDLE POSITION SP FEET
 2. LEFT NEEDLE POSITION SP FEET
 3. SUPER HIGH SHANK SP FEET
 4. SUPER HIGH LEVEL SP FEET
- SP = SNAP ON (ONE STEP)

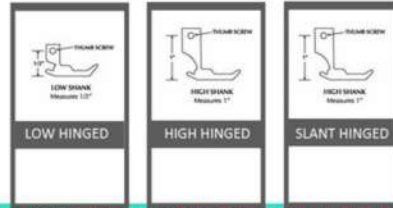

ALL SNAP ON (ONE STEP) SEWING FEET CAN BE MADE IN THE FOLLOWING TYPE



BUTTON SEWIN PLATE

MODEL NO	RJ-E01
Description	GRAY COLOR
MATERIAL	POM PLASTIC
MOQ	300 PCS



QUILTING GUIDE FOR WALKING FOOT

MODEL NO	RJ-Q06
Description	ALL METAL
MATERIAL	METAL
MOQ	100 PCS



MULTI LOW SHANK

MODEL NO	RJ-815
Description	LOW SHANK
MATERIAL	ZINC ALLOY
MOQ	100 PCS

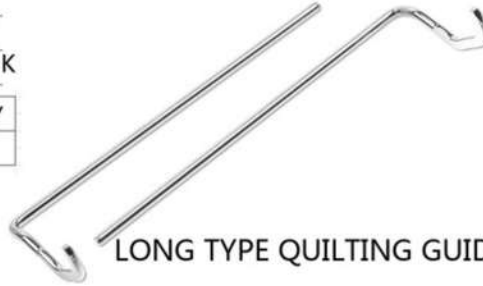

LONG TYPE QUILTING GUIDE

MODEL NO	RJ-Q08
Description	ALL METAL
MATERIAL	METAL
MOQ	100 PCS



DARNING PLATE

MODEL NO	RJ-DP01
Description	THIN FABRIC
MATERIAL	PLASTIC
MOQ	300 PCS



DARNING PLATE

MODEL NO	RJ-DP02
Description	HEAVY FABRIC
MATERIAL	PLASTIC
MOQ	300 PCS



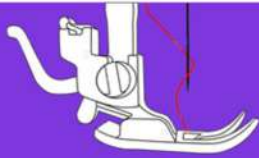

ONE STEP
Fits Our Shank adapter

ONLY SNAP ON
WITH RJ-7P00

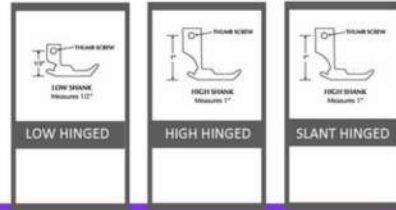

機
縫

台灣製造 一品質 服務客製化



MODEL NO	RJ-7P01
Description	NO REFLECTED
MATERIAL	ZINC ALLOY, METAL
MOQ	100 PCS

1/4 INCH EDGE JOINING FOOT



MODEL NO	RJ-7P02
Description	NO REFLECTED
MATERIAL	ZINC ALLOY, METAL
MOQ	100 PCS

STITCH IN THE DITCH FOOT



MODEL NO	RJ-7P03
Description	NO REFLECTED
MATERIAL	ZINC ALLOY
MOQ	100 PCS

ZIPPER/CORDING FOOT



MODEL NO	RJ-7P04
Description	NO REFLECTED
MATERIAL	ZINC ALLOY, PLASTIC
MOQ	100 PCS

STANDARD FOOT



MODEL NO	RJ-7P05
Description	NO REFLECTED
MATERIAL	ZINC ALLOY
MOQ	100 PCS

OPEN TOE 9MM FOOT



MODEL NO	RJ-7P06
Description	NO REFLECTED
MATERIAL	ZINC ALLOY, PLASTIC METAL
MOQ	100 PCS

BUTTON SEWING FOOT



MODEL NO	RJ-7P07
Description	NO REFLECTED
MATERIAL	ZINC ALLOY, PLASTIC METAL
MOQ	100 PCS

BLIND HEM FOOT



MODEL NO	RJ-7P08
Description	NO REFLECTED
MATERIAL	ZINC ALLOY, PLASTIC METAL
MOQ	100 PCS

FANCY STITCH FOOT



MODEL NO	RJ-7P09
Description	NO REFLECTED
MATERIAL	ZINC ALLOY METAL
MOQ	100 PCS

OVERCASTING FOOT



MODEL NO	RJ-7P10
Description	NO REFLECTED
MATERIAL	ZINC ALLOY, PLASTIC METAL
MOQ	100 PCS

FANCY STITCH FOOT



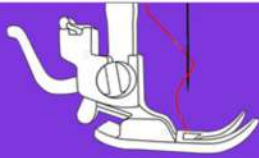

ONE STEP
Fits Our Shank adapter

ONLY SNAP ON
WITH RJ-7P00

機
縫

台灣製造 一品質 服務客製化

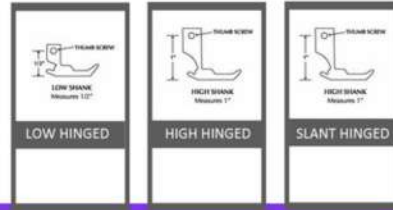

1/4 INCH QUILTING FOOT

MODEL NO	RJ-7P11
Description	NO REFLECTED
MATERIAL	ZINC ALLOY
MOQ	100 PCS



STANDARD ZIG ZAG FOOT

MODEL NO	RJ-7P12
Description	NO REFLECTED
MATERIAL	ZINC ALLOY
MOQ	100 PCS



STANDARD RED LINE FOOT

MODEL NO	RJ-7P13
Description	NO REFLECTED
MATERIAL	ZINC ALLOY
MOQ	100 PCS



9MM CORDING FOOT

MODEL NO	RJ-7P14
Description	CLEAR
MATERIAL	PLASTIC
MOQ	100 PCS



BRAIDING FOOT

MODEL NO	RJ-7P15
Description	NO REFLECTED
MATERIAL	ZINC ALLOY
MOQ	100 PCS



7/9 HOLE CORDING FOOT

MODEL NO	RJ-7P16
Description	NO REFLECTED
MATERIAL	ZINC ALLOY
MOQ	100 PCS



ZIPPER/CORDING FOOT

MODEL NO	RJ-7P17
Description	NO REFLECTED
MATERIAL	ZINC ALLOY
MOQ	100 PCS



3MM ROUND HEM FOOT

MODEL NO	RJ-7P18
Description	NO REFLECTED
MATERIAL	ZINC ALLOY
MOQ	100 PCS



CLEAR RED LINE FOOT

MODEL NO	RJ-7P19
Description	NO REFLECTED
MATERIAL	ZINC ALLOY
MOQ	100 PCS



TEFLON FOOT

MODEL NO	RJ-7P20
Description	TEFLON
MATERIAL	POM + TEFLON
MOQ	100 PCS



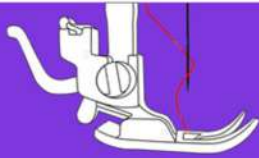

ONE STEP
Fits Our Shank adapter

ONLY SNAP ON
WITH RJ-7P00



機
縫

台灣製造 一品質 服務客製化



6MM OPEN TOE FOOT

MODEL NO	RJ-7P21
Description	NO REFLECTED
MATERIAL	ZINC ALLOY
MOQ	100 PCS



CLEAR ZIG ZAG FOOT

MODEL NO	RJ-7P22
Description	CLEAR
MATERIAL	PLASTIC
MOQ	100 PCS



3MM HEMMING FOOT

MODEL NO	RJ-7P23
Description	NO REFLECTED
MATERIAL	ZINC ALLOY
MOQ	100 PCS



INVISIBLE ZIPPER FOOT

MODEL NO	RJ-7P24
Description	CLEAR
MATERIAL	PLASTIC
MOQ	100 PCS



THIS GROOVE IS IMPORTANT



MINI CORDING FOOT

MODEL NO	RJ-7P25
Description	CLEAR
MATERIAL	PLASTIC
MOQ	100 PCS



GATHERING FOOT

MODEL NO	RJ-7P26
Description	NO REFLECTED
MATERIAL	ZINC ALLOY
MOQ	100 PCS



6MM BEADING FOOT

MODEL NO	RJ-7P27
Description	CLEAR
MATERIAL	PLASTIC
MOQ	100 PCS



DECORATIVE FOOT

MODEL NO	RJ-7P28
Description	NO REFLECTED
MATERIAL	ZINC ALLOY
MOQ	100 PCS



WELTING FOOT
1. SINGLE
2. DOUBLE

MODEL NO	RJ-7P29
Description	SINGLE
MODEL NO	RJ-7P29-2
Description	DOUBLE
MATERIAL	PLASTIC
MOQ	100 PCS



11+2 FEET KIT

MODEL NO	RJ-211P+2
Description	11+2 PLUS
MATERIAL	ZINC ALLOY
MOQ	100 SETS



機 縫

RENUYI

MADE IN TAIWAN



ONE STEP
Fits Our Shank adapter

ONLY SNAP ON
WITH RJ-7P00



MODEL NO	RJ-215
Description	15 PCS
MATERIAL	PP BOX+FEET
MOQ	100 SETS

15 PCS OPTIONAL FEET BOX PACKAGE



MODEL NO	RJ-217
Description	17 PCS
MATERIAL	PP BOX+FEET
MOQ	100 SETS

17 PCS OPTIONAL FEET BOX PACKAGE



MODEL NO	RJ-207QT+1
Description	7+1 PCS
MATERIAL	PP BOX+FEET
MOQ	100 SETS

7+1 PCS OPTIONAL FEET BOX PACKAGE



MODEL NO	RJ-208-1
Description	8 PCS
MATERIAL	PP BOX+FEET
MOQ	100 SETS

8 PCS OPTIONAL FEET BOX PACKAGE



MODEL NO	RJ-207MM
Description	7 PCS
MATERIAL	PP BOX+FEET
MOQ	100 SETS

7 PCS OPTIONAL FEET BOX PACKAGE



MODEL NO	RJ-207HM
Description	7 PCS
MATERIAL	PP BOX+FEET
MOQ	100 SETS

7 PCS OPTIONAL FEET BOX PACKAGE



MODEL NO	RJ-206A
Description	6 PCS
MATERIAL	PP BOX + FEET
MOQ	100 SETS

6 PCS OPTIONAL FEET BOX PACKAGE



MODEL NO	RJ-206B
Description	6+1 PCS
MATERIAL	PP BOX+FEET
MOQ	100 SETS

6+1 PCS OPTIONAL FEET BOX PACKAGE



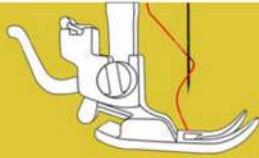

ONE STEP
Fits Our Shank adapter

ONLY SNAP ON
WITH RJ-7P00

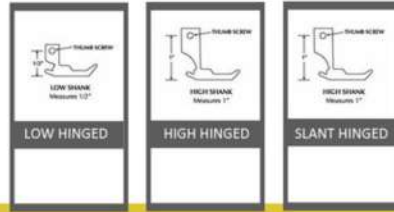

機
縫

台灣製造 一品質 服務客製化



9 PCS OPTIONAL FEET BOX PACKAGE

MODEL NO	RJ-209A
Description	9 PCS
MATERIAL	PP BOX + FEET
MOQ	100 SETS



(FOR NO REFLECTED TYPE SEWING MACHINE)
25 PCS BOBBINS BOX PACKAGE

MODEL NO	RJ-BB-25-P
Description	25 PCS
MATERIAL	PP PLASTIC
MOQ	160 BOX



(FOR K TYPE SEWING MACHINE)
25 PCS BOBBINS BOX PACKAGE

MODEL NO	RJ-BB-25-K1
Description	25 PCS
MATERIAL	PP PLASTIC
MOQ	160 BOX

3 SERIES AVAILABLE
ASK AS ABOUT
RJ-BB-25K1
RJ-BB-25K2
RJ-BB-25K3



(FOR REGULAR SEWING MACHINE)
25 PCS BOBBINS BOX PACKAGE

MODEL NO	RJ-BB-25-R
Description	REGULAR 25
MATERIAL	PP PLASTIC
MOQ	160 BOX

RJ-BB-25-R (REGULAR)
RJ-BB-25-E (N TYPE)
RJ-BB-25-N (EMPTY BOX)



8 PCS OPTIONAL FEET BOX PACKAGE

MODEL NO	RJ-208
Description	8 PCS
MATERIAL	PP BOX + FEET
MOQ	100 SETS



7 PCS OPTIONAL FEET BOX PACKAGE

MODEL NO	RJ-207-1
Description	7 PCS
MATERIAL	PP BOX + FEET
MOQ	100 SETS



3 PCS OPTIONAL FEET BOX PACKAGE

MODEL NO	RJ-203HM
Description	3 PCS
MATERIAL	PP BOX + FEET
MOQ	100 SETS



28 PCS BOBBINS BOX PACKAGE

MODEL NO	RJ-BB-28N
Description	EMPTY
MODEL NO	RJ-BB-28R
Description	W/BOBBIN
MATERIAL	PP BOX
MOQ	600 BOX



RENJI

MADE IN TAIWAN



ONE STEP
Fits Our Shank adapter

ONLY SNAP ON
WITH RJ-7P00

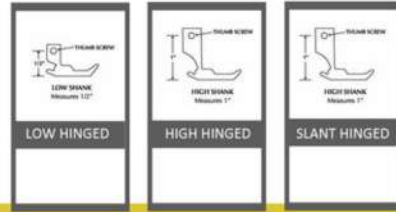

機
縫

台灣製造 一品質 服務客製化

56. POPULAR SEWING FEET KIT



16 PCS OPTIONAL FEET BOX PACKAGE

MODEL NO	RJ-216
Description	16 PCS
MATERIAL	PP BOX
MOQ	500 SETS



8 PCS OPTIONAL FEET BOX PACKAGE

MODEL NO	RJ-208K
Description	8 PCS
MATERIAL	PP BOX
MOQ	100 SETS



6 PCS OPTIONAL FEET BOX PACKAGE

MODEL NO	RJ-206K
Description	6 PCS
MATERIAL	PP BOX
MOQ	100 SETS



6 PCS OPTIONAL FEET BOX PACKAGE

MODEL NO	RJ-207NS-1
Description	6 PCS
MATERIAL	PP BOX
MOQ	100 SETS
MODEL NO	RJ-207NS-2
Description	7 PCS



拚布

台灣製造 一品質 服務客製化

RENUYI

MADE IN TAIWAN



THE MAT
CUTTING MAT
SHOCK-ABSORBING MAT
CLEAR CUTTING MAT
ROTATING CUTTING MAT
FOLDING CUTTING MAT



Default unit: metric system **MADE IN TAIWAN | THE, MAT**
 With your logo printed on the mat,
 we will charge you plate-making fee for the first time



NEW!
 SHOCK-ABSORBING MAT FOR
 1. SEWING MACHINES
 2. OVER LOCK MACHINES
 3. COVER STITCH MACHINES
 (NON-SLIP! FOR SEWING MACHINE!)

MODEL NO	RJ-SAM4848
Description	48x48 CM
MODEL NO	RJ-SAM4060
Description	40x60 CM
MODEL NO	RJ-SAM4070
Description	40x70 CM
MATERIAL	PER
MOQ	500 PACK

AVAILABLE COLOR
 red, mint,
 purple, magenta

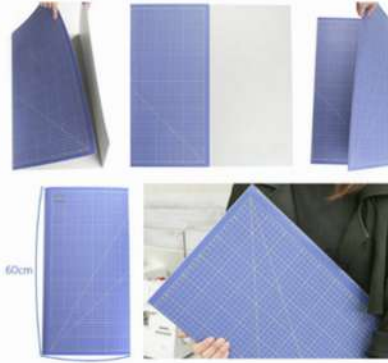

3-FOLDING CUTTING MAT (BLUE COLOR + GOLD LINE)

MODEL NO	RJ-FM3022-3
Description	30x22CMx2.5MM
MODEL NO	RJ-FM4530-3
Description	45x30cmx2.5MM
MODEL NO	RJ-FM6045-3
Description	60x45CMx2.5MM
MODEL NO	RJ-FM6090-3
Description	60x90CMx2.5MM
MATERIAL	PVC
MOQ	100 PCS



2-FOLDING CUTTING MAT (GREEN COLOR+WHITE LINE)

MODEL NO	RJ-FM3022-2
Description	30x22CMx2.5MM
MODEL NO	RJ-FM4530-2
Description	45x30cmx2.5MM
MODEL NO	RJ-FM6045-2
Description	60x45CMx2.5MM
MODEL NO	RJ-FM6090-2
Description	60x90CMx2.5MM
MATERIAL	PVC
MOQ	200 PCS

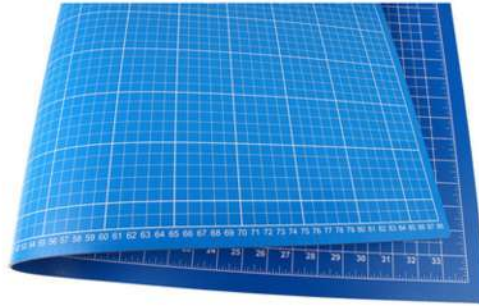

2 SIDE PRINT CUTTING MAT (BLUE COLOR+WHITE LINE)
 CM + INCH TYPE (THE BIGGEST SIZE : A1)
 5 STRATUM, 3MM THICKNESS

MODEL NO	RJ-CM3022-2V
Description	30x22CMx3MM
MODEL NO	RJ-CM4530-2V
Description	45x30cmx3MM
MODEL NO	RJ-CM6045-2V
Description	60x45cmx3MM
MODEL NO	RJ-CM6090-2V
Description	60x90cmx3MM
MATERIAL	PVC
MOQ	300 PCS

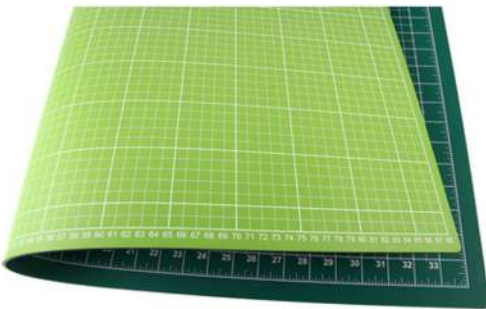

2 COLOR PRINT CUTTING MAT (SP COLOR)
 CM + INCH TYPE (THE BIGGEST SIZE : A1)
 5 STRATUM, 3MM THICKNESS
 CHECK THE FOLLOWING AVAILABLE COLOR:

MODEL NO	RJ-CM3022-2CR
Description	30x22CMx3MM
MODEL NO	RJ-CM4530-2CR
Description	45x30cmx3MM
MODEL NO	RJ-CM6045-2CR
Description	60x45CMx3MM
MODEL NO	RJ-CM6090-2CR
Description	60x90CMx3MM
MATERIAL	PVC
MOQ	500 PCS

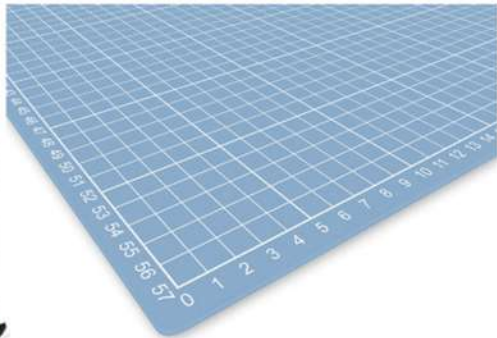

REGULAR CUTTING MAT (BLUE COLOR+WHITE LINE)
 (THE BIGGEST SIZE FOR BLUE COLOR : A1)
 5 STRATUM, 3MM THICKNESS

MODEL NO	RJ-CM3022-BE
Description	30x22CMx3MM
MODEL NO	RJ-CM4530-BE
Description	45x30cmx3MM
MODEL NO	RJ-CM6045-BE
Description	60x45cmx3MM
MODEL NO	RJ-CM6090-BE
Description	60x90cmx3MM
MATERIAL	PVC
MOQ	300 PCS



PURPLE AND DEEP PURPLE

PINK AND DEEP PURPLE

YELLOW AND RED

BLACK AND GRAY



REMARK
 Please note that with cutting mats bigger than A1, we only have "GREEN" color.
 All other sizes can be customized.





RENUYI

MADE IN TAIWAN



THE MAT

CUTTING MAT
SHOCK-ABSORBING MAT
CLEAR CUTTING MAT
ROTATING CUTTING MAT
FOLDING CUTTING MAT



Default unit: metric system **MADE IN TAIWAN | THE, MAT**
With your logo printed on the mat,
we will charge you plate-making fee for the first time

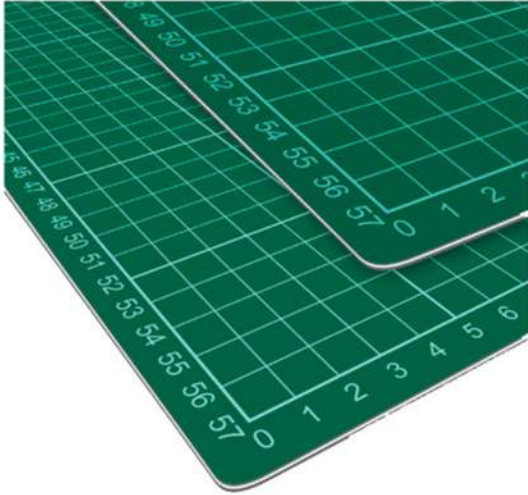

REGULAR CUTTING MAT (GREEN COLOR)
(THE BIGGEST SIZE FOR BLUE COLOR : CUSTOMIZED)
5 STRATUM, 3MM THICKNESS (ONLY FOR A1-A4)
5 STRATUM, 2.5MM THICKNESS (FOR BIGGER THAN A1)

MODEL NO	RJ-CM3022
Description	30x22CMx3MM

MODEL NO	RJ-CM4530
Description	45x30cmx3MM

MODEL NO	RJ-CM6045
Description	60x45cmx3MM

MODEL NO	RJ-CM6090
Description	60x90cmx3MM

MATERIAL	PVC
MOQ	300 PCS

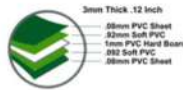

MODEL NO	RJ-CM18291
Description	182x91CMx2.5mm

MODEL NO	RJ-CM16080
Description	160x80CMx2.5mm

MODEL NO	RJ-CM12090
Description	120x90CMx2.5mm

MODEL NO	RJ-CM12080
Description	120x80CMx2.5mm

MODEL NO	RJ-CM10676
Description	106x76CMx2.5mm

MODEL NO	RJ-CM150100
Description	150x100CMx2.5mm

MODEL NO	RJ-CM200100
Description	200x100CMx2.5mm

MATERIAL	PVC
MOQ	DEPENDS

MATERIAL	PVC
MOQ	DEPENDS

MATERIAL	PVC
MOQ	DEPENDS

MATERIAL	PVC
MOQ	DEPENDS

MATERIAL	PVC
MOQ	DEPENDS

MATERIAL	PVC
MOQ	DEPENDS

MATERIAL	PVC
MOQ	DEPENDS

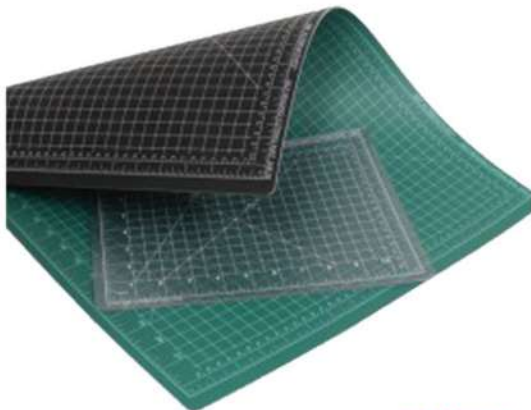

REGULAR TRANSPARENT CUTTING MAT (CLEAR VIEW)

MODEL NO	RJ-CMC3022
Description	30x22CMx3MM

MODEL NO	RJ-CMC4530
Description	45x30cmx3MM

MODEL NO	RJ-CMC6045
Description	60x45cmx3MM

MODEL NO	RJ-CMC6090
Description	60x90cmx3MM

MATERIAL	PVC
MOQ	300 PCS



RUBBER SPONGE CUTTING MAT
2MM PVC + 1MM RUBBER SPONGE (BLACK SBR)

MODEL NO	RJ-CMP3022
Description	30x22CMx3MM

MODEL NO	RJ-CMP4530
Description	45x30cmx3MM

MODEL NO	RJ-CMP6045
Description	60x45cmx3MM

MODEL NO	RJ-CMP6090
Description	60x90cmx3MM

MATERIAL	2MM pvc 1MM SBR
MOQ	300 PCS

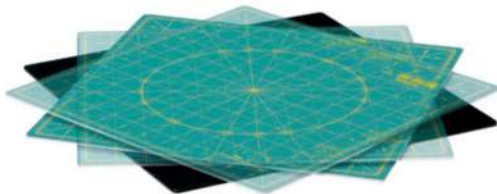

ROTATING CUTTING MAT

MODEL NO	RM-3030
Description	30x30cm

MODEL NO	RM-4545
Description	45x45cm

MATERIAL	PVC
MOQ	300 PCS



ROTATING IRON BOARD

MODEL NO	RJ-CMU0912
Description	9"x12"

MODEL NO	RJ-CMU1218
Description	12"x18"

MODEL NO	RJ-CMD0905
Description	9.5" CIRCLE

MODEL NO	RJ-CMD0112
Description	12" CIRCLE

MOQ FOR THESE 3 MODELS

MATERIAL	PVC+FABRIC
MOQ	300 PCS EACH

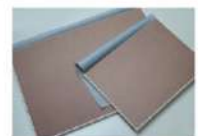

Ironing & Sandy Table

MODEL NO	RJ-CMS0912
Description	9"x12"

MODEL NO	RJ-CMS1218
Description	12"x18"



PORTABLE FOLDING MAT





MADE IN TAIWAN | THE, knife

With your logo printed on the rotary CUTTER , we will charge you plate-making fee for the first time

RENUYI

MADE IN TAIWAN

THE KNIFE
ROTARY CUTTER
(CHANGEABLE)
CRAFT KNIFE
CUTTER SET

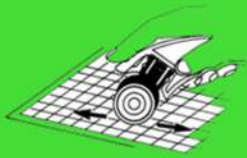

Slip function

SKS7

ROTARY CUTTER (MACARON DESIGN)
28MM AND 45MM AVAILABLE

MODEL NO	RJ-RC28MD
Description	28MM
MODEL NO	RJ-RC45MD
Description	45MM
MATERIAL	SKS7
MOQ	1152 CARDS

7 COLORS FOR CHOICE.

1. Macaron blue 305C
2. Macaron orange 032C
3. Macaron green 367C
4. COOL GRAY 11C
5. Macaron dark blue 295C
6. Macaron purple 195C
7. Macaron dark green 336C



PAT.



CHOOSE COLOR AND WE WILL LET YOU KNOW THE NEW MODEL NUMBER.

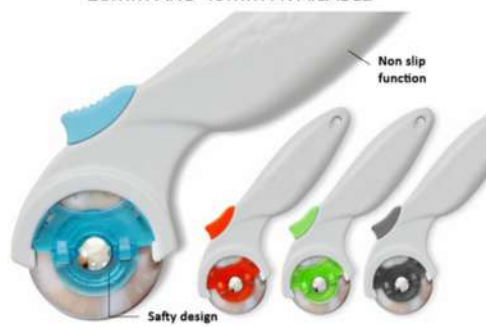

Non slip function

Safety design

LEATHER ROTARY CUTTER (MACARON DESIGN)
28MM AND 45MM AVAILABLE

MODEL NO	RJ-RC28MD-1
Description	28MM
MODEL NO	RJ-RC45MD-1
Description	45MM
MATERIAL	SKS7
MOQ	1152 CARDS

7 COLORS FOR CHOICE.

1. Macaron blue 305C
2. Macaron orange 032C
3. Macaron green 367C
4. COOL GRAY 11C
5. Macaron dark blue 295C
6. Macaron purple 195C
7. Macaron dark green 336C



PAT.

HOW TO CHANGE THE BLADE?



CHOOSE COLOR AND WE WILL LET YOU KNOW THE NEW MODEL NUMBER.



CHANGEABLE BLADE SKS7 FOR RJ-RC28MD AND RJ-RC45MD SERIES

MODEL NO	RJ-28R-2
Description	28MM x 2 PCS
MODEL NO	RJ-28R-5
Description	28MM x 5 PCS
MODEL NO	RJ-28R-10
Description	28MM x 10 PCS
MATERIAL	SKS7
MOQ	500 CD/BOX

MODEL NO	RJ-45R-2
Description	45MM x 2 PCS
MODEL NO	RJ-45R-5
Description	45MM x 5 PCS
MODEL NO	RJ-45R-10
Description	45MM x 10 PCS
MATERIAL	SKS7
MOQ	500 CD/BOX

BLADE TYPE.
1. STRAIGHT STITCH (REGULAR) RJ-45R SERIES (2, 5, 10 PCS)
2. OTHER TYPE, PLEASE ASK US.

NOTE.
THIS RJ-45R SERIES BLADE ARE FOR 'RJ-RC45MD & RJ-RC45MD-1'
DO NOT ARRANGE THESE BLADE WITH OTHER PRODUCTS.



ROTARY CUTTER WITH CUSHION GRIP DIA 28MM AND 45MM AVAILABLE

MODEL NO	RJ-RC28MR-OE
Description	28MM ORANGE GRAY
MODEL NO	RJ-RC45MR-OE
Description	45MM ORANGE GRAY
MODEL NO	RJ-RC60MR-OE
Description	60MM ORANGE GRAY
MATERIAL	SKS-7
MOQ	1000 CARDS

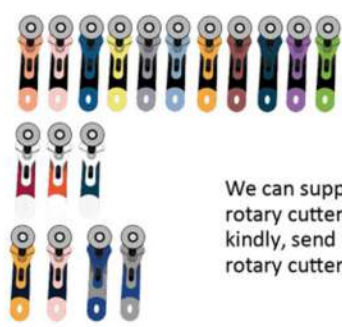

We can supply OEM/ODM color for this type rotary cutter (RJ-RC28MR, RJ-RC45MR, RJ-RC-60MR) kindly, send us a mail to discuss your own rotary cutter!



台灣製造 一品質 服務客製化

拼布



MADE IN TAIWAN | THE, knife

With your logo printed on the rotary CUTTER , we will charge you plate-making fee for the first time

THE KNIFE
ROTARY CUTTER
(CHANGEABLE)
CRAFT KNIFE
CUTTER SET

RENYU
 MADE IN TAIWAN

COMMON (REGULAR)
 FOR ALL ROTARY CUTTER WE HAVE
 NOT FOR RJ-RC28 45 MD SERIES



MODEL NO	RJ-28C-10
Description	28MM
MODEL NO	RJ-45C-10
Description	45MM
MODEL NO	RJ-60C-10
Description	60MM
MATERIAL	SKS7
MOQ	300 BOX

CHANGEABLE BLADE SKS7
 FOR COMMON (REGULAR) TYPE



28MM SKS7 ROTARY CUTTER

MODEL NO	RJ-RC28Y
Description	28MM+1BLADE
MATERIAL	SKS7
MOQ	500 CARDS

NOTE.
 CARD WILL BE YOUR OWN DESIGN



28MM&45MM
 SKS7 ROTARY CUTTER

MODEL NO	RJ-RC28D
Description	28MM
MODEL NO	RJ-RC45D
Description	45MM
MATERIAL	SKS7
MOQ	500 CARDS



45MM SKS7 ROTARY CUTTER

MODEL NO	RJ-RC45E
Description	45MM
MATERIAL	SKS7
MOQ	500 CARDS



45MM HAND ROTARY CUTTER

MODEL NO	RJ-RC45W
Description	45MM
MATERIAL	SKS7
MOQ	1000 CARDS



18MM ROTARY CUTTER

MODEL NO	RJ-RC18R
Description	18MM
MATERIAL	SKS7
MOQ	500 CARDS



PRECISION KNIFE (FINGERTIP CONTROL)
 CRAFT KNIFE W/CUSHION GRIP)

MODEL NO	RJ-6210B
Description	BLUE COLOR
MODEL NO	RJ-6210R
Description	RED COLOR
MODEL NO	RJ-6210Y
Description	YELLOW COLOR
MATERIAL	PLASTIC
MOQ	500 PCS

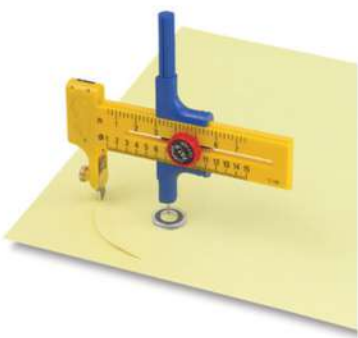

COMPASS CUTTER (ROTARY)

MODEL NO	RJ-6219Y
Description	YELLOW COLOR
MODEL NO	RJ-6219K
Description	BLACK COLOR
MODEL NO	RJ-6219R
Description	RED COLOR
MATERIAL	PLASTIC
MOQ	300 PCS



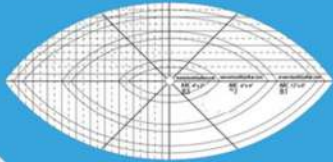

THE QUILTING RULER

IRONING RULER
QUILTING RULER
NON SLIP RULER



MADE IN TAIWAN | THE, RULER

With your logo printed on the QUILTING RULER ,
we will charge you plate-making fee for the first time

拚布

台灣製造 一品質 服務客製化

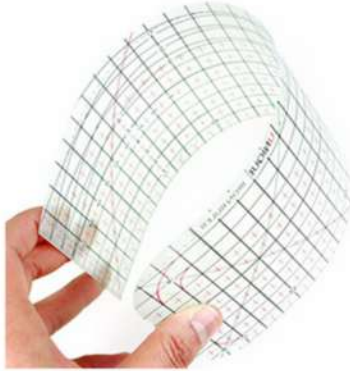

IRONING RULER

MODEL NO	RJ-IR1030
Description	10x30 CM
MODEL NO	RJ-IR1020
Description	10x20 CM
MATERIAL	SP PLASTIC
MOQ	500 PCS

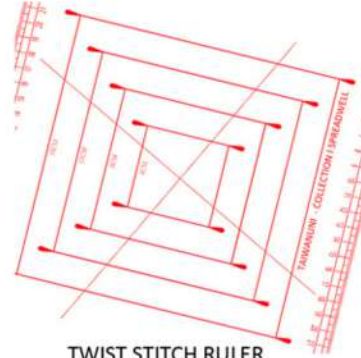

TWIST STITCH RULER
(RED COLOR PRINT)

MODEL NO	RJ-SR0010
Description	RED PRINT
MATERIAL	PLASTIC
MOQ	300 PCS

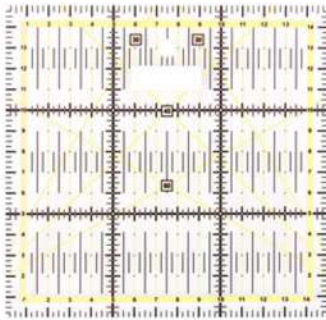

15x15CM QUILTING RULER

MODEL NO	RJ-1515E
Description	15x15cm YELLOW COLOR
MATERIAL	PLASTIC
MOQ	300 PCS

NOTE : THE OTHER COLOR
MOQ WILL DEPENDS
ON OUR WAREHOUSE.

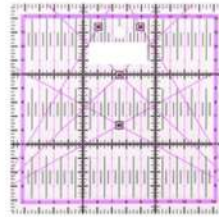

15x15CM (PURPLE)
MODEL : RJ-1515P

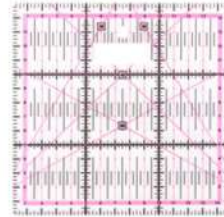

15x15CM (PINK)
MODEL : RJ-1515N

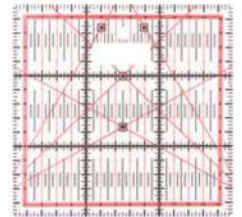

15x15CM (RED)
MODEL : RJ-1515R

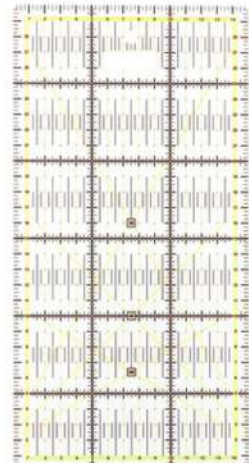

30x15CM QUILTING RULER

MODEL NO	RJ-1530E
Description	30x15cm YELLOW COLOR
MATERIAL	PLASTIC
MOQ	300 PCS

NOTE : THE OTHER COLOR
MOQ WILL DEPENDS
ON OUR WAREHOUSE.

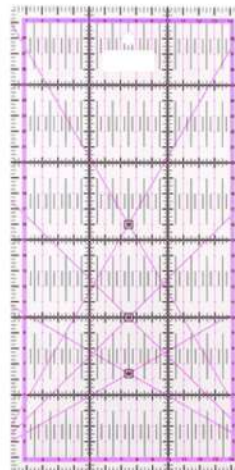

30x15CM (PURPLE)
MODEL : RJ-1530P

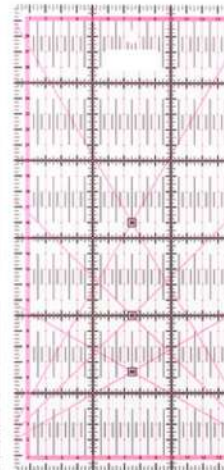

30x15CM (PINK)
MODEL : RJ-1530N

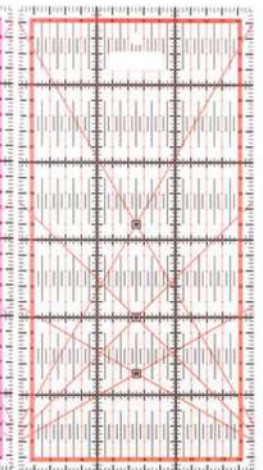

30x15CM (RED)
MODEL : RJ-1530R

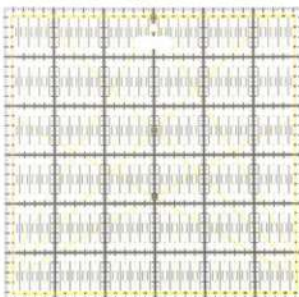

30x30CM QUILTING RULER

MODEL NO	RJ-3030E
Description	30x30cm YELLOW COLOR
MATERIAL	PLASTIC
MOQ	300 PCS

NOTE : THE OTHER COLOR
MOQ WILL DEPENDS
ON OUR WAREHOUSE.

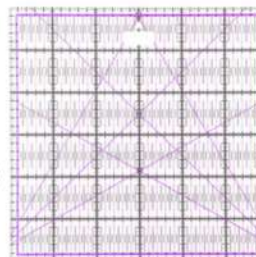

30x30CM (PURPLE)
MODEL : RJ-3030P

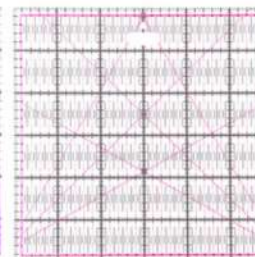

30x30CM (PINK)
MODEL : RJ-3030N

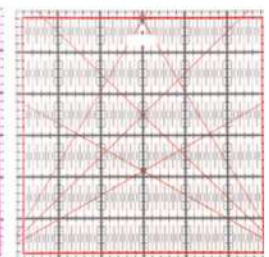

30x30CM (RED)
MODEL : RJ-3030R



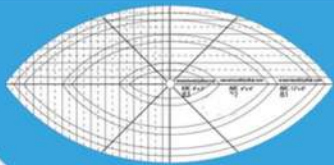

THE QUILTING RULER

IRONING RULER
QUILTING RULER
NON SLIP RULER

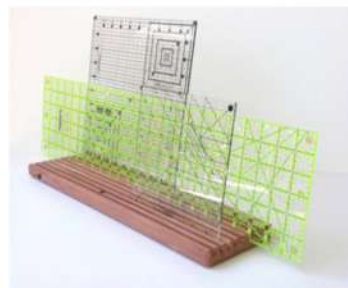

MADE IN TAIWAN | THE, RULER

With your logo printed on the QUILTING RULER,
we will charge you plate-making fee for the first time

拚布

台灣製造 一品質 服務客製化

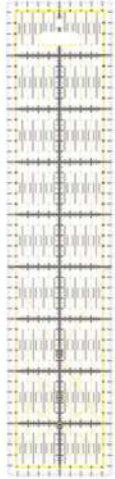

MODEL NO	RJ-1045E
Description	10x45cm YELLOW COLOR
MATERIAL	PLASTIC
MOQ	300 PCS

10X45CM QUILTING RULER



MODEL NO	RJ-1560E
Description	15x60cm YELLOW COLOR
MATERIAL	PLASTIC
MOQ	300 PCS

15X60CM QUILTING RULER

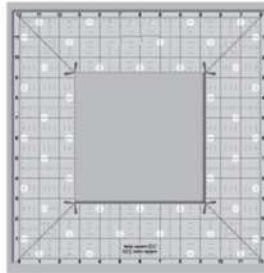

SQUARED CUTTING RULER(CM)

MODEL NO	RJ-0125KTR
Description	CM TYPE
MATERIAL	PLASTIC
MOQ	500 PCS

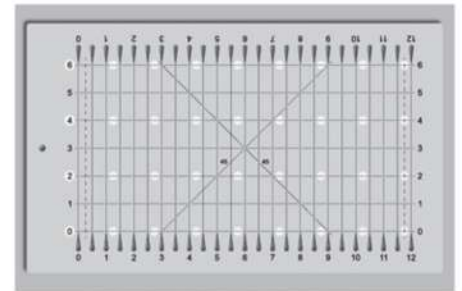

FRINGE MAKER RULER (CM)

MODEL NO	RJ-0915KTR
Description	CM TYPE
MATERIAL	PLASTIC
MOQ	500 PCS

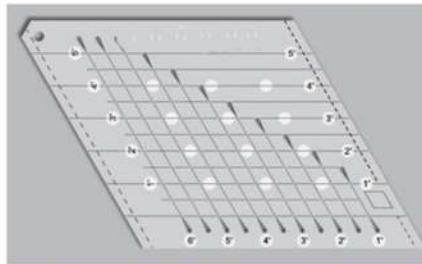
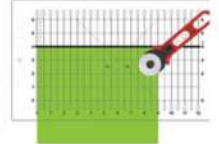

DIAMOND CUT RULER 60 DEGREE (CM)

MODEL NO	RJ-6010KTR
Description	CM TYPE
MATERIAL	PLASTIC
MOQ	500 PCS

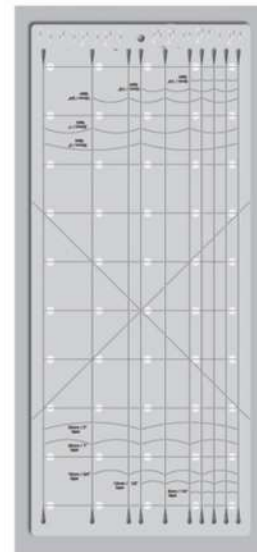

Tape Maker Pro, non-slip cutting ruler(CM)

MODEL NO	RJ-0921KTR
Description	CM TYPE
MATERIAL	PLASTIC
MOQ	300 PCS

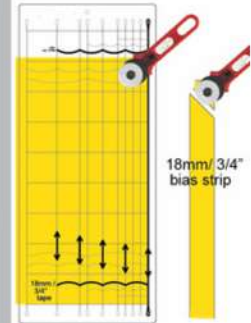

18mm/ 3/4" bias strip

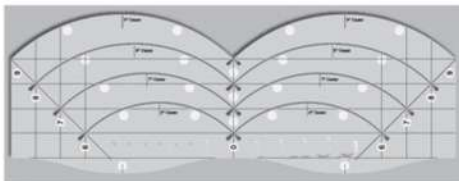

CREATIVE FRAM RULER (CM)

MODEL NO	RJ-6518KTR
Description	CM TYPE
MATERIAL	PLASTIC
MOQ	300 PCS

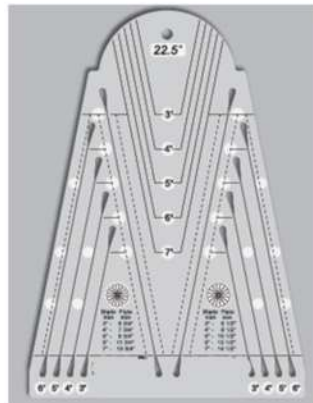
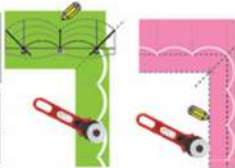

DRESDEN MAKER RULER
1. 12CM (RJ-3010KTR)
2. 16CM (RJ-2250KTR)

MODEL NO	RJ-3010KTR
Description	12CM TYPE
MODEL NO	RJ-2250KR
Description	16CM TYPE
MATERIAL	PLASTIC
MOQ	300 PCS

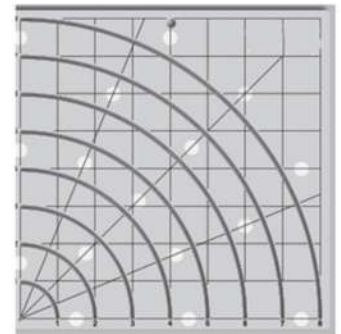
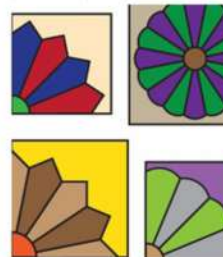

MODEL NO	RJ-8585KTR
Description	CM TYPE
MATERIAL	PLASTIC
MOQ	30 PCS



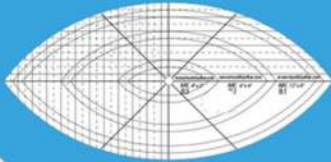

THE QUILTING RULER

IRONING RULER
QUILTING RULER
NON SLIP RULER



MADE IN TAIWAN | THE, RULER

With your logo printed on the QUILTING RULER,
we will charge you plate-making fee for the first time

拚布

台灣製造 一品質 服務客製化

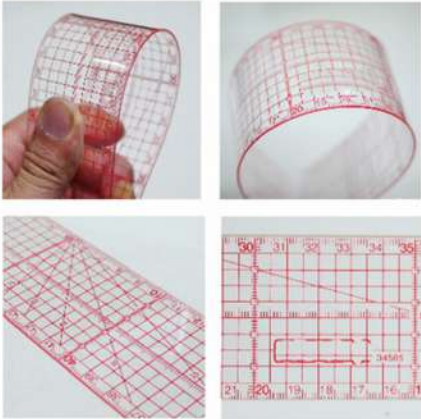

PATCHWORK RULER (CLEAR)

MODEL NO	RJ-2005R
Description	20x5x0.1cm

MODEL NO	RJ-3005R
Description	30x5x0.1cm

MODEL NO	RJ-5005R
Description	50x5x0.1cm

MODEL NO	RJ-6005R
Description	60x5x0.1cm

MATERIAL	TRANSPARENT ACRYLIC
MOQ	300 PCS

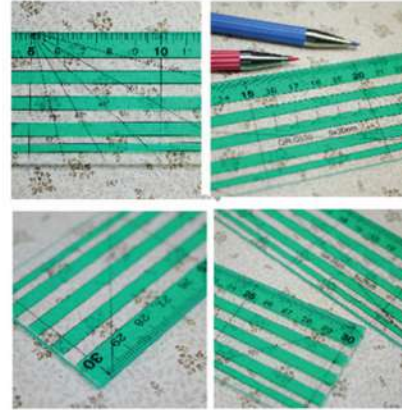

TWO TONES PATCHWORK RULER

MODEL NO	RJ-0315G
Description	3x15x0.3cm

MODEL NO	RJ-0515G
Description	5x15x0.3cm

MODEL NO	RJ-0525G
Description	5x25x0.3cm

MODEL NO	RJ-0530G
Description	5x30x0.3cm

MODEL NO	RJ-0535G
Description	5x35x0.3cm

MATERIAL	TRANSPARENT ACRYLIC
MOQ	300 PCS (GREEN) 1500PCS (OTHER COLOR)

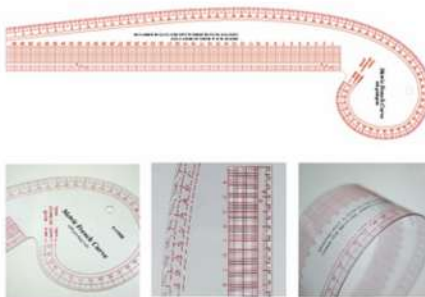

FRENCH CUREVE RULER

MODEL NO	RJ-1501R
Description	CM TYPE

MATERIAL	TRANSPARENT ACRYLIC
MOQ	300 PCS

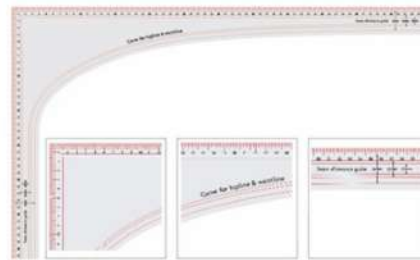

DRESSMAKERS SQUARE RULER

MODEL NO	RJ-1511R
Description	CM TYPE

MATERIAL	TRANSPARENT ACRYLIC
MOQ	300 PCS

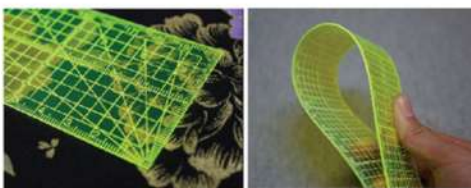

FLURO QUILTING RULER
FLEXABLE PATCHWORK FOOT 1MM

MODEL NO	RJ-2005FR
Description	20x5x0.1cm

MODEL NO	RJ-3005FR
Description	30x5x0.1cm

MODEL NO	RJ-5005FR
Description	50x5x0.1cm

MODEL NO	RJ-6005FR
Description	60x5x0.1cm

MATERIAL	PLASTIC
MOQ	300 PCS



FLURO QUILTING RULER
PATCHWORK FOOT 3MM

MODEL NO	RJ-0315FR
Description	3x15x0.3cm

MODEL NO	RJ-0515FR
Description	5x15x0.3cm

MODEL NO	RJ-0525FR
Description	5x25x0.3cm

MODEL NO	RJ-0530FR
Description	5x30x0.3cm

MODEL NO	RJ-0535FR
Description	3x15x0.3cm

MATERIAL	PLASTIC
MOQ	300 PCS



CIRCLE TEMPLATE RULER

MODEL NO	RJ-5520B
Description	3.5"(9CM) BLUE COLOR

MODEL NO	RJ-5520R
Description	3.0"(8CM) RED COLOR

MODEL NO	RJ-5520Y
Description	2.5"(6.5CM) YELLOW COLOR

MODEL NO	RJ-5520N
Description	2.0"(5CM) MINT COLOR

MODEL NO	RJ-5520G
Description	1.5"(4CM) GRAY COLOR

MODEL NO	RJ-5520(E)
Description	5 SIZE IN 1

MATERIAL	PLASTIC
MOQ	500 PCS/SETS

WITH 1/4" SEAM ALLOWANCE & EASY SEAM SLOTS.
CUT WITH OUR CUTTING MAT & ROTARY CUTTER



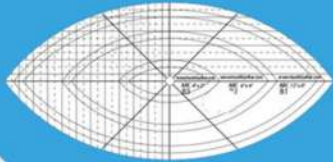

THE QUILTING RULER

IRONING RULER
QUILTING RULER
NON SLIP RULER

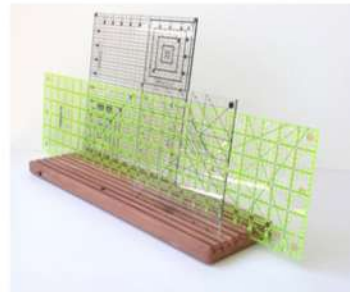

MADE IN TAIWAN | THE, RULER

With your logo printed on the QUILTING RULER,
we will charge you plate-making fee for the first time

拚布

台灣製造 一品質 服務 客製化



MODEL NO	RJ-5530B
Description	3.5"(9CM) BLUE COLOR
MODEL NO	RJ-5530R
Description	3.0"(8CM) RED COLOR
MODEL NO	RJ-5530Y
Description	2.5"(6.5CM) YELLOW COLOR



60 DEGREE TRAIANGLE TEMPLATE RULER

MODEL NO	RJ-5530N
Description	2.0"(5CM) MINT COLOR
MODEL NO	RJ-5530G
Description	1.5"(4CM) GARY COLOR
MODEL NO	RJ-5530(E)
Description	5 IN 1 PACK



MODEL NO	RJ-5560B
Description	3.5"(9CM) BLUE COLOR
MODEL NO	RJ-5560R
Description	3.0"(8CM) RED COLOR
MODEL NO	RJ-5560Y
Description	2.5"(6.5CM) YELLOW COLOR



HEXGON TEMPLATE

MODEL NO	RJ-5560N
Description	2.0"(5CM) MINT COLOR
MODEL NO	RJ-5560G
Description	1.5"(4CM) GARY COLOR
MODEL NO	RJ-5560(E)
Description	5 IN 1 PACK/SET



MODEL NO	RJ-5540B
Description	3.5"(9cm) BLUE COLOR
MODEL NO	RJ-5540R
Description	3.0"(8CM) RED COLOR
MODEL NO	RJ-5540Y
Description	2.5"(6.5CM) YELLOW COLOR
MODEL NO	RJ-5540N
Description	2.0"(5CM) MINT COLOR
MODEL NO	RJ-5540G
Description	1.5"(4CM) GARY COLOR
MODEL NO	RJ-5540(E)
Description	5 IN 1 PACK



SQUARE TEMPLATE RULER

Includes 3 laser cut template: 6.0", 5.0", 4.0". Special frosted material for clarity on light- and dark-material. Template with 1/4" seam allowance and easy seam slots. Easy to cut with rotating mat and rotary cutter.



NOTE:
WRITE A MAIL TO US,
IF YOU WANNA LARGER SIZE FOR
THESE TEMPLATE



HEXAGON 8 PCS TEMPLATE SETS

MODEL NO	RJ-8808X
Description	HEXAGON
MATERIAL	PLASTIC
MOQ	500 SETS

MODEL NO	RJ-8808XR
Description	HEXAGON PAPER

MATERIAL	PAPER
MOQ	1000 SETS



DIAMOND 8 PCS TEMPLATE SETS

MODEL NO	RJ-8808D
Description	DIAMOND
MATERIAL	PLASTIC
MOQ	500 SETS

MODEL NO	RJ-8808DR
Description	DIAMOND PAPER

MATERIAL	PAPER
MOQ	1000 SETS



TRIANGUAR 8 PCS TEMPLATE SETS

MODEL NO	RJ-8808U
Description	TRIANGUAR

MATERIAL	PLASTIC
MOQ	500 SETS

MODEL NO	RJ-8808UR
Description	TRIANGUAR PAPER

MATERIAL	PAPER
MOQ	1000 SETS



PENTAGON 8 PCS TEMPLATE SETS

MODEL NO	RJ-8808T
Description	PENTAGON

MATERIAL	PLASTIC
MOQ	500 SETS

MODEL NO	RJ-8808TR
Description	PENTAGON PAPER

MATERIAL	PAPER
MOQ	1000 SETS





MADE IN TAIWAN | THE, RULER

With your logo printed on the QUILTING RULER, we will charge you plate-making fee for the first time

RENUYI

MADE IN TAIWAN

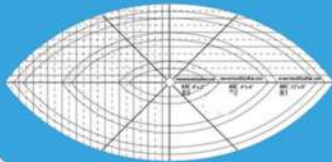

THE QUILTING RULER

IRONING RULER
QUILTING RULER
NON SLIP RULER

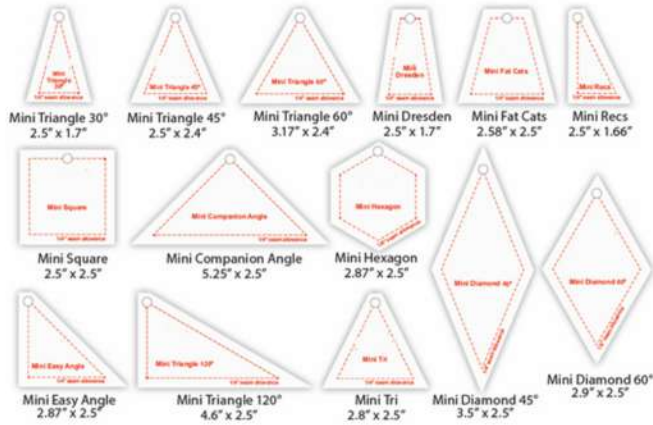

MINI TEMPLATE 14 DIFFERENT SHAPES

MODEL NO	RJ-MT30	MODEL NO	RJ-MR2566	MODEL NO	RJ-MT120
Description	MINI TRIANGLE	Description	MINI RECS	Description	MINI TRIANGLE
MODEL NO	RJ-MT45	MODEL NO	RJ-MS2525	MODEL NO	RJ-MT2825
Description	MINI TRIANGLE	Description	MINI SQUARE	Description	MINI TRI
MODEL NO	RJ-MT60	MODEL NO	RJ-MCA525	MODEL NO	RJ-MD45
Description	MINI TRIANGLE	Description	MINI COMPANION ANGLE	Description	MINI DIAMOND
MODEL NO	RJ-MD2517	MODEL NO	RJ-MH2875	MODEL NO	RJ-MD60
Description	MINI DRESDEN	Description	MINI HEXAGON	Description	MINI DIAMOND
MODEL NO	RJ-MFC258	MODEL NO	RJ-MEA2875	MATERIAL	PLASTIC
Description	MINI FAT CATS	Description	MINI EASY ANGLE	MOQ	500 PCS EACH

MODEL NO	RJ-MT30	MODEL NO	RJ-MR2566	MODEL NO	RJ-MT120
Description	MINI TRIANGLE	Description	MINI RECS	Description	MINI TRIANGLE
MODEL NO	RJ-MT45	MODEL NO	RJ-MS2525	MODEL NO	RJ-MT2825
Description	MINI TRIANGLE	Description	MINI SQUARE	Description	MINI TRI
MODEL NO	RJ-MT60	MODEL NO	RJ-MCA525	MODEL NO	RJ-MD45
Description	MINI TRIANGLE	Description	MINI COMPANION ANGLE	Description	MINI DIAMOND
MODEL NO	RJ-MD2517	MODEL NO	RJ-MH2875	MODEL NO	RJ-MD60
Description	MINI DRESDEN	Description	MINI HEXAGON	Description	MINI DIAMOND
MODEL NO	RJ-MFC258	MODEL NO	RJ-MEA2875	MATERIAL	PLASTIC
Description	MINI FAT CATS	Description	MINI EASY ANGLE	MOQ	500 PCS EACH

MODEL NO	RJ-MT30	MODEL NO	RJ-MR2566	MODEL NO	RJ-MT120
Description	MINI TRIANGLE	Description	MINI RECS	Description	MINI TRIANGLE
MODEL NO	RJ-MT45	MODEL NO	RJ-MS2525	MODEL NO	RJ-MT2825
Description	MINI TRIANGLE	Description	MINI SQUARE	Description	MINI TRI
MODEL NO	RJ-MT60	MODEL NO	RJ-MCA525	MODEL NO	RJ-MD45
Description	MINI TRIANGLE	Description	MINI COMPANION ANGLE	Description	MINI DIAMOND
MODEL NO	RJ-MD2517	MODEL NO	RJ-MH2875	MODEL NO	RJ-MD60
Description	MINI DRESDEN	Description	MINI HEXAGON	Description	MINI DIAMOND
MODEL NO	RJ-MFC258	MODEL NO	RJ-MEA2875	MATERIAL	PLASTIC
Description	MINI FAT CATS	Description	MINI EASY ANGLE	MOQ	500 PCS EACH

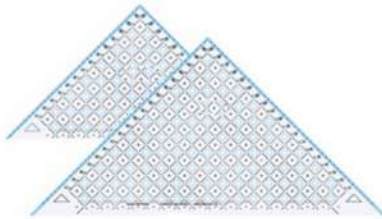

TRIANGLE QUILTING RULER

MODEL NO	RJ-1214R
Description	1/2 SQUARE TO 14CM
MODEL NO	RJ-1219R
Description	1/2 SQUARE TO 19CM
MATERIAL	PLASTIC
MOQ	300 PCS EACH

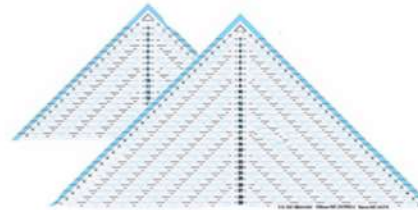

TRIANGLE QUILTING RULER

MODEL NO	RJ-1419R
Description	1/4 SQUARE TO 19CM
MODEL NO	RJ-1429R
Description	1/4 SQUARE TO 29CM
MATERIAL	PLASTIC
MOQ	300 PCS EACH



RENUYI

MADE IN TAIWAN

THE SEWING

CHACO PEN
TAPE MAKER
AWL, ETC

MADE IN TAIWAN | THE, RULER

With your logo printed on the SEWING TOOLS ,
we will charge you plate-making fee for the first time

拼布

台灣製造 一品質 服務客製化



QUILTERS HOLDING CLIPS
27x10.2 mm
opening 9.5mm max



QUILTERS HOLDING CLIPS
33x18.2 mm
opening: 10.5mm max



QUILTERS HOLDING CLIPS
56x12mm.
opening: 16mm max



THIMBLE (RUBBER)

MODEL NO	RJ-2610R
Description	RED COLOR
MODEL NO	RJ-2610P
Description	PINK COLOR
MODEL NO	RJ-2610E
Description	ORANGE COLOR
MODEL NO	RJ-2610U
Description	PURPLE COLOR
MODEL NO	RJ-2610Y
Description	YELLOW COLOR

MODEL NO	RJ-2610M
Description	MINT COLOR
MODEL NO	RJ-2610B
Description	BLUE COLOR
MODEL NO	RJ-2610G
Description	GARY COLOR
MATERIAL	PLASTIC METAL
MOQ	500 PCS

MODEL NO	RJ-3318R
Description	RED COLOR
MODEL NO	RJ-3318P
Description	PINK COLOR
MODEL NO	RJ-3318Y
Description	YELLOW COLOR
MODEL NO	RJ-3318U
Description	PURPLE COLOR
MODEL NO	RJ-3318C
Description	CLEAR
MODEL NO	RJ-3318E
Description	BLUE COLOR

MODEL NO	RJ-3318M
Description	MINT COLOR
MATERIAL	PLASTIC METAL
MOQ	500 PCS

MODEL NO	RJ-5612R
Description	RED COLOR
MODEL NO	RJ-5612P
Description	PINK COLOR
MODEL NO	RJ-5612M
Description	MINT COLOR
MODEL NO	RJ-5612P
Description	PURPLE COLOR
MODEL NO	RJ-5612B
Description	BLUE COLOR

MATERIAL	PLASTIC METAL
MOQ	500 PCS

MODEL NO	RJ-0307M
Description	MINT COLOR
MATERIAL	RUBBER
MOQ	10,000 PCS



SEAM RIPPER



AWL



THIMBLE (METAL)



THIMBLE (METAL)



THINBLE (LEATHER COIN)

MODEL NO	RJ-RA211RS
Description	SHORT
MODEL NO	RJ-RA211RL
Description	LONG
MATERIAL	PLASTIC, METAL
MOQ	5000 PCS

MODEL NO	RJ-0512W
Description	WHITE HANDLE
MATERIAL	RJ-0512R
MOQ	RED HANDLE

MODEL NO	RJ-0305BE-6
Description	#6
MODEL NO	RJ-0305BE-7
Description	#7
MODEL NO	RJ-0305BE-8
Description	#8
MATERIAL	METAL
MOQ	10,000 PCS

MODEL NO	RJ-0306V
Description	SLIVER COLOR
MODEL NO	RJ-0306G
Description	GOLD COLOR
MATERIAL	METAL
MOQ	10,000 PCS

MODEL NO	RJ-0308C
Description	LEATHER COIN
MATERIAL	LEATHER
MOQ	10,000 PCS



THE SEWING

CHACO PEN
TAPE MAKER
AWL, ETC



MADE IN TAIWAN | THE, RULER

With your logo printed on the SEWING TOOLS ,
we will charge you plate-making fee for the first time

拚布

台灣製造 一品質 服務客製化



ADJUSTABLE CLOTH CLAMP

MODEL NO	RJ-0603CLM-6
Description	6" TYPE
MODEL NO	RJ-0603CLM-8
Description	8" TYPE
MODEL NO	RJ-0603CLM-10
Description	10" TYPE
MATERIAL	METAL
MOQ	600 PCS



CLOTH CLAMP

MODEL NO	RJ-0603CLMC
Description	REGULAR
MATERIAL	METAL
MOQ	600 PCS



PATTERN NOTCHER

MODEL NO	RJ-0824PN-1/8"
Description	1/8" TYPE
MODEL NO	RJ-0824PN-3/16"
Description	3/16" TYPE
MATERIAL	METAL
MOQ	600 PCS



QUILTING RULER SUCKER

MODEL NO	RJ-0828 QR-W
Description	WOOD HANDLE
MODEL NO	RJ-0828 QR-P
Description	PLASTIC HANDLE
MATERIAL	PLASTIC WOOD
MOQ	600 PCS



TRACING WHEEL

MODEL NO	RJ-0830PW
Description	WHITE COLOR
MODEL NO	RJ-0830PR
Description	RED COLOR
MATERIAL	PLASTIC METAL
MOQ	600 PCS



TWEEZER

MODEL NO	RJ-0906TR
Description	SPECIAL
MATERIAL	PLASTIC METAL
MOQ	600 PCS



PIN CUSHION

MODEL NO	RJ-1110B
Description	BLUE COLOR
MODEL NO	RJ-1110R
Description	RED COLOR
MATERIAL	WOOD FABRIC
MOQ	1000 PCS



PIN CUSHION (RING)

MODEL NO	RJ-1112-R
Description	RED COLOR
MATERIAL	PLASTIC FABRIC
MOQ	600 PCS



BOBIN SAVER (WITHOUT BOBBINS)

MODEL NO	RJ-0102P	MATERIAL	PLASTIC
Description	PINK (ROUND)	MOQ	5000 SETS
MODEL NO	RJ-0102B		
Description	BLUE (ROUND)		
MODEL NO	RJ-0103P	MATERIAL	PLASTIC
Description	PINK (OVAL)	MOQ	1000 SETS
MODEL NO	RJ-0103B		
Description	BLUE (OVAL)		



THE, SEWING KIT

MODEL NO	RJ-269
Description	SEWING KIT
MATERIAL	PLASTIC
MOQ	1000 BOX



拚布

台灣製造 一品質 服務 客製化

RENUYI

MADE IN TAIWAN

THE SEWING

CHACO PEN
TAPE MAKER
AWL, ETC

MADE IN TAIWAN | THE, RULER

With your logo printed on the SEWING TOOLS ,
we will charge you plate-making fee for the first time



EMBROIDERY HOOPS (WOOD)

MODEL NO	RJ-0724
Description	ASK US
MATERIAL	WOOD METAL
MOQ	500 PCS

ASK US FOR THE SIZE
WE WILL LET U KNOW
THE MODEL NUMBER



48MM FLOWER PIN

MODEL NO	RJ-0417FR
Description	FLOWER PIN
MATERIAL	METAL
MOQ	10,000 PCS

ASK US THE COLOR
WE WILL LET YOU KNOW
THE MODEL NUMBER



48MM QUILTING GLASS HEAD PINS

MODEL NO	RJ-0906GP
Description	GLASS HEAD
MATERIAL	METAL
MOQ	10,000 PCS

ASK US THE COLOR
WE WILL LET YOU KNOW
THE MODEL NUMBER



PIN CUSHION (FOR SEWING MACHINE)

MODEL NO	RJ-0960PN
Description	FOR SEWING MACHINE
MATERIAL	PLASTIC, FABRIC
MOQ	100 SETS



6, 12, 18, 25MM TAPE MAKER
6MM - GREEN COLOR
12MM - YELLOW COLOR
18MM - RED COLOR
25MM - BLUE COLOR

MODEL NO	RJ-12006
Description	6MM
MODEL NO	RJ-12012
Description	12MM
MODEL NO	RJ-12018
Description	18MM
MODEL NO	RJ-12025
Description	25MM
MATERIAL	PLASTIC METAL
MOQ	480 CARDS



CREASE MARKER

MODEL NO	RJ-3810
Description	WHITE
MATERIAL	PLASTIC
MOQ	200 PCS



FINGER PRESSER

MODEL NO	RJ-3820W
Description	WHITE
MATERIAL	PLASTIC
MOQ	200 PCS



CHACO PEN AND REFILL

MODEL NO	RJ-2000B	MODEL NO	RJ-2000G
Description	BLUE COLOR	Description	GARY COLOR
MODEL NO	RJ-2000R	MATERIAL	PLASTIC
Description	RED COLOR	MOQ	576 CARDS EACH
MODEL NO	RJ-2000Y		
Description	YELLOW COLOR		
MODEL NO	RJ-2000W		
Description	WHITE COLOR		
MODEL NO	RJ-2001B	MODEL NO	RJ-2001W
Description	BLUE COLOR	Description	WHITE COLOR
MODEL NO	RJ-2001R	MODEL NO	RJ-2001G
Description	RED COLOR	Description	GARY COLOR
MODEL NO	RJ-2001Y	MATERIAL	PLASTIC
Description	YELLOW COLOR	MOQ	60 CARDS EACH



TAPE MAKER SET PACK

MODEL NO	RJ-1203
Description	12 18 25MM PACK
MODEL NO	RJ-1204
Description	6 12 18 25MM PACK
MATERIAL	PLASTIC
MOQ	216 CARDS EACH



RENUYI

MADE IN TAIWAN



THE SEWING

CHACO PEN
TAPE MAKER
AWL, ETC

MADE IN TAIWAN | THE, RULER

With your logo printed on the SEWING TOOLS ,
we will charge you plate-making fee for the first time

拚布

台灣製造 一品質 服務客製化



AUTO QUILTING PENCIL & REFILL
Exterior : red, blue, long (sliver),
short (sliver) color 4 type available.

MODEL NO	RJ-6237R
Description	EXTERIOR:RED
MODEL NO	RJ-6237B
Description	EXTERIOR:BLUE
MODEL NO	RJ-6237S
Description	SHORT
MODEL NO	RJ-6237L
Description	LONG
MODEL NO	RJ-6231-4
Description	4 COLOR REFILL
MATERIAL	METAL PLASTIC
MOQ	600 PCS



QUILTING PENCIL
COLOR : PINK, WHITE
BLUE, GARY, BLUE, YELLOW

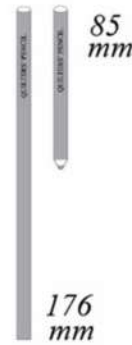

MODEL NO	RJ-6238P
Description	PINK
MODEL NO	RJ-6238W
Description	WHITE
MODEL NO	RJ-6238G
Description	GARY
MODEL NO	RJ-6238B
Description	BLUE
MODEL NO	RJ-6238Y
Description	YELLOW
MATERIAL	WOOD
MOQ	1000 PCS EACH



CHACO LINER
COLOR : PINK, WHITE, YELLOW, BLUE

MODEL NO	RJ-2000W
Description	WHITE COLOR
MODEL NO	RJ-2000P
Description	PINK COLOR
MODEL NO	RJ-2000B
Description	BLUE COLOR
MODEL NO	RJ-2000Y
Description	YELLOW COLOR
MATERIAL	PLASTIC
MOQ	600 PCS



REFILL FOR CHACO LINER 2000 SERIES
COLOR : PINK, WHITE, BLUE, YELLOW

MODEL NO	RJ-2001P
Description	PINK COLOR
MODEL NO	RJ-2001B
Description	BLUE COLOR
MODEL NO	RJ-2001Y
Description	YELLOW COLOR
MODEL NO	RJ-2001W
Description	WHITE COLOR
MATERIAL	PLASTIC
MOQ	600 PCS



CHACO WHEEL
COLOR : PINK, WHITE, YELLOW, BLUE

MODEL NO	RJ-4000P
Description	PINK COLOR
MODEL NO	RJ-4000B
Description	BLUE COLOR
MODEL NO	RJ-4000Y
Description	YELLOW COLOR
MODEL NO	RJ-4000W
Description	WHITE COLOR
MATERIAL	PLASTIC
MOQ	600 PCS



REFIL FOR CHACO WHEEL 4000 SERIES
COLOR : PINK, WHITE, BLUE, YELLOW

MODEL NO	LS-4001P
Description	PINK COLOR
MODEL NO	LS-4001B
Description	BLUE COLOR
MODEL NO	LS-4001Y
Description	YELLOW COLOR
MODEL NO	LS-4001W
Description	WHITE COLOR
MATERIAL	PLASTIC
MOQ	600 PCS

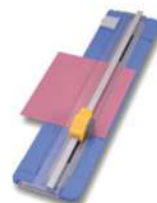
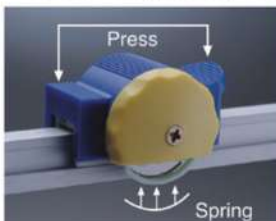

← MINI ROTARY TRIMMER

MODEL NO	RJ-72000	MATERIAL	METAL, PLASTIC
Description	200MM	MOQ	96 SETS
MODEL NO	RJ-73110	MATERIAL	METAL, PLASTIC
Description	311MM	MOQ	96 SETS





BOBINS & BOBBIN CASE

**MADE IN TAIWAN
BOBINS
BOBBIN CASE
HOOK**



MADE IN TAIWAN | BOBBIN!

拚布

台灣製造 品質 服務 客製化



BOBBIN (PLASTIC)



**DIAMETER: 21.6MM
HEIGHT: 8.6MM
AXIS DIAMETER: 6MM**

MODEL NO	9033P
Description	DEEP BLUE
MODEL NO	9033P-B
Description	CLEAR BLUE
MODEL NO	9033P-C
Description	CLEAR
MATERIAL	PLASTIC
MOQ	1000 PCS



BOBBIN (PLASTIC)



**DIAMETER: 21.2MM
HEIGHT: 9MM
AXIS DIAMETER: 6.1MM**

MODEL NO	136492
Description	CLEAR BLUE
MATERIAL	PLASTIC
MOQ	1000 PCS



BOBBIN (PLASTIC)



**DIAMETER: 20.4MM
HEIGHT: 11.5MM
AXIS DIAMETER: 6.2MM**

MODEL NO	2518P
Description	CLEAR BLUE
MODEL NO	2518P-Y
Description	CLEAR YELLOW
MODEL NO	2518P-C
Description	CLEAR
MATERIAL	PLASTIC
MOQ	1000 PCS



**DIAMETER: 21.6MM
HEIGHT: 10.4MM
AXIS DIAMETER: 5.6MM**

MODEL NO	4125612-45
Description	CLEAR GREEN
MATERIAL	PLASTIC
MOQ	1000 PCS



**DIAMETER: 21.4MM
HEIGHT: 9.1MM
AXIS DIAMETER: 6MM**

MODEL NO	4120975-45
Description	CLEAR
MATERIAL	PLASTIC
MOQ	1000 PCS



**DIAMETER: 25.7MM
HEIGHT: 9.6MM
AXIS DIAMETER: 2.88MM**

MODEL NO	181551
Description	CLEAR BLUE
MATERIAL	PLASTIC
MOQ	1000 PCS



**DIAMETER: 25.7MM
HEIGHT: 9.3MM
AXIS DIAMETER: 3.4MM**

MODEL NO	312956-451
Description	center clear
MATERIAL	plastic, metal
MOQ	3000 pcs



**DIAMETER: 20.5MM
HEIGHT: 10.8MM
AXIS DIAMETER: 6.2MM**

MODEL NO	17222P
Description	CLEAR
MODEL NO	17222PB
Description	CLEAR BLUE
MATERIAL	PLASTIC
MOQ	1000 PCS



RENYU

MADE IN TAIWAN



BOBINS & BOBBIN CASE

MADE IN TAIWAN
BOBINS
BOBBIN CASE
HOOK



MADE IN TAIWAN | BOBBIN!

拚布

台灣製造 一品質 服務客製化

71. SEWING MACHINE BOBBIN
BOBBIN CASE & HOOK



BOBBIN CASE

MODEL NO	421326
Description	bobbin case
MATERIAL	plastic, metal
MOQ	500 pcs



BOBBIN CASE

MODEL NO	XC0066051
Description	BOBBIN CASE
MATERIAL	PLASTIC METAL
MOQ	300 PCS



BOBBIN CASE

MODEL NO	XC3153051
Description	BOBBIN CASE
MATERIAL	PLASTIC METAL
MOQ	300 PCS



1. BOBBIN
2. LATCH LEVER
3. HOOK
4. BOBBIN CASE

WRITE MAIL TO US,
WE WILL LET YOU KNOW
MORE ITEMS THAT WE HAVE.



COLORFUL BOBBINS

We produce many color of bobbins (plastic, metal, etc)
write mail to us, we will let you know the color we have.
NOTE : Each color MOQ = 50,000 pcs



MADE IN TAIWAN SINCE 1951 NOW & FOREVER

THE SEWING MACHINE
SEWING FEET FACTORY

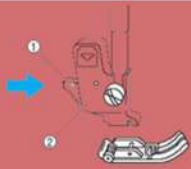

2016 NEW

NEW CLEAR SEWING MACHINE FEET 2016-2025

CLEAR SEWING FEET



MADE IN TAIWAN | NEW!

新

台灣製造 一品質 服務客製化



FLAT HEMMING FOOT

MODEL NO	RJ-C701
Description	CLEAR
MATERIAL	SP PLASTIC
MOQ	500 PCS



STITCH IN THE DTICH FOOT

MODEL NO	RJ-C702
Description	CLEAR
MATERIAL	SP PLASTIC
MOQ	500 PCS



QUILTING ZIG ZAG FOOT

MODEL NO	RJ-C703
Description	CLEAR
MATERIAL	SP PLASTIC
MOQ	500 PCS



GATHERING FOOT

MODEL NO	RJ-C704
Description	CLEAR BLUE
MATERIAL	SP PLASTIC
MOQ	500 PCS



DARNING FOOT (CIRCLE)

MODEL NO	RJ-C705
Description	CLEAR
MATERIAL	SP PLASTIC
MOQ	500 PCS



PIPING FOOT (SINGLE SIDE)

MODEL NO	RJ-C706
Description	CLEAR
MATERIAL	SP PLASTIC
MOQ	500 PCS



QUILTING DARNING FOOT

MODEL NO	RJ-C707
Description	CLEAR
MATERIAL	SP PLASTIC
MOQ	500 PCS



PIN TUCK FOOT

MODEL NO	RJ-C708-5
Description	5-GROOVE

MODEL NO	RJ-C708-7
Description	7-GROVE

MATERIAL	SP PLASTIC
MOQ	500 PCS



FELLEING FOOT

MODEL NO	RJ-C709-4
Description	FOR 4MM
MODEL NO	RJ-C709-6
Description	FOR 6MM
MATERIAL	SP PLASTIC
MOQ	500 PCS

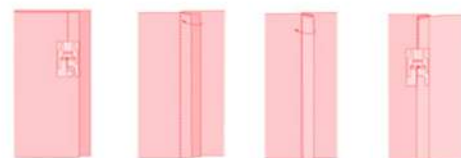

LEFT

MADE IN TAIWAN

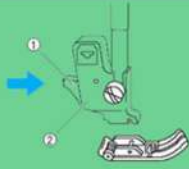

LEFT NEEDLE POSITION
FOR COMPUTER SEWING MACHINE
NOT FOR 5MM

NOTE
THESE FEET FOR 7MM
COMPUTER SEWING MACHINE ONLY
NOT FOR 5MM
LEFT NEEDLE POSITION

73. THE LEFT NEEDLE POSITION SEWING FEET

台灣製造 一品質 服務客製化



NON STICK FOOT

MODEL NO	RJ-7301PWT
Description	LEFT NEEDLE
MATERIAL	SP PLASTIC
MOQ	100 PCS



APPLIQUE FOOT

MODEL NO	A9
Description	LEFT NEEDLE
MATERIAL	PLASTIC
MOQ	100 PCS



STRAIGHT STITCH FOOT

MODEL NO	RJ-7304W-J
Description	LEFT NEDLE
MATERIAL	ZINC ALLOY
MOQ	100 PCS



BUTTON SEWING FOOT

MODEL NO	A4-P
Description	LEFT NEEDLE
MATERIAL	PLASTIC
MOQ	100 PCS



SATIN STITCH FOOT B

MODEL NO	A7
Description	LEFT NEEDLE
MATERIAL	PLASTIC METAL
MOQ	100 PCS



GATHERING FOOT

MODEL NO	200003009
Description	LEFT NEEDLE
MATERIAL	ZINC ALLOY
MOQ	100 PCS



EVEN FEED/EALKING FOOT W/QUILTING GUIDE

MODEL NO	RJ-7248LFQ6
Description	LEFT NEEDLE
MATERIAL	METAL PLASTIC
MOQ	100 SETS



OVEREDGE FOOT

MODEL NO	A2-M
Description	LEFT NEEDLE
MATERIAL	ZINC ALLOY
MOQ	100 PCS



DOUBLE PIPING FOOT

MODEL NO	200002008
Description	LEFT NEEDLE
MATERIAL	ZINC ALLOY
MOQ	100 PCS



ZIPPER FOOT

MODEL NO	RJ-7306E
Description	LEFT NEEDLE
MATERIAL	ZINC ALLOY
MOQ	100 PCS



MADE IN TAIWAN SINCE 1951 NOW & FOREVER

THE SEWING MACHINE SEWING FEET FACTORY

LEFT

MADE IN TAIWAN

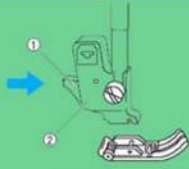

LEFT NEEDLE POSITION
FOR COMPUTER SEWING MACHINE
NOT FOR 5MM

NOTE
THESE FEET FOR 7MM
COMPUTER SEWING MACHINE ONLY
NOT FOR 5MM
LEFT NEEDLE POSITION

台灣製造 一品質 服務客製化

74. THE LEFT NEEDLE POSITION SEWING FEET



ZIPPER/CORDING FOOT

MODEL NO	ZIPPER FOOT
Description	LEFT NEEDLE
MATERIAL	ZINC ALLOY
MOQ	100 PCS

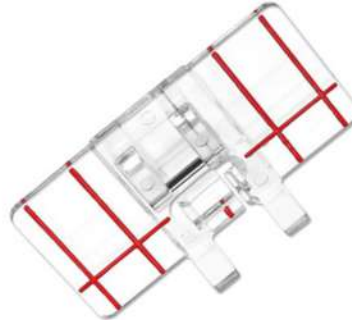

BOARDER GUIDE FOOT

MODEL NO	RJ-605N
Description	LEFT NEEDLE
MATERIAL	PLASTIC
MOQ	100 PCS



CLEAR ROLLER FOOT

MODEL NO	RJ-7304WN
Description	LEFT NEDLE
MATERIAL	PLASTIC METAL
MOQ	100 PCS



INVISIBLE ZIPPER FOOT

MODEL NO	RJ-601ZNF
Description	LEFT NEDLE
MATERIAL	ZINC ALLOY
MOQ	100 PCS



ADJUSTABLE BUTONHOLE FOOT

MODEL NO	RJ-7302WN
Description	LEFT NEEDLE
MATERIAL	METAL PLASTIC
MOQ	50 PCS



DARNING FOOT

MODEL NO	RJ-701N
Description	LEFT NEEDLE
MATERIAL	METAL PLASTIC
MOQ	100 PCS



ALL PURPOSE FOOT

MODEL NO	RJ-7301N
Description	LEFT NEDLE
MATERIAL	ZINC ALLOY
MOQ	100 PCS



ALL PURPOSE FOOT

MODEL NO	RJ-802A
Description	LEFT NEEDLE
MATERIAL	ZINC ALLOY PLASTIC
MOQ	100 PCS



3-CORDING FOOT

MODEL NO	RJ-7309WN
Description	LEFT NEEDLE
MATERIAL	ZINC ALLOY
MOQ	100 PCS



ALL PURPOSE FOOT (OLD)

MODEL NO	RJ-802A-1
Description	LEFT NEEDLE
MATERIAL	ZINC ALLOY PLASTIC
MOQ	100 PCS



壓鈕



MADE IN TAIWAN | BUTTON PLIERS

With your logo printed on the **BUTTON PLIERS**, we will charge you plate-making fee for the first time

HANDLE BUTTON PLIERS

RENUYI

MADE IN TAIWAN



**BUTTON PLIERS
(ONE STEP)**



MODEL NO	RJ-6409PE
Description	ONE STEP
MODEL NO	RJ-6411PE
Description	ONE STEP
MATERIAL	METAL, PLASTIC
MOQ	1000 CARDS

* FOR PLASTIC BUTTONS ONLY

* FOR PLASTIC & METAL BUTTONS

Swatch

	A	B	C	D	E	F	G	H	HJ	JK
1										
2										
3										
4										
5										
6										
7										
8										
9										

SNAP BUTTONS CAP SIZE				SNAP P/B SIZE			
	CAP	SOCKET	STUD	POST			
11 Buttons					A	B	C
12 Buttons							
13 Buttons							
14 Buttons							

MODEL NO	RJ-6409PE-9MMB
Description	WHITE, BLACK COLOR

MODEL NO	RJ-6409PE-9MMC
Description	CHOOSE WHITE COLOR YOU WANTED

MATERIAL	SP PLASTIC
MOQ	2000 PCS

MODEL NO	RJ-6409PE-13MMB
Description	WHITE, BLACK COLOR

MODEL NO	RJ-6409PE-13MMC
Description	CHOOSE WHITE COLOR YOU WANTED

MATERIAL	SP PLASTIC
MOQ	1000 PCS

MODEL NO	RJ-6409PE-11MMB
Description	WHITE, BLACK COLOR

MODEL NO	RJ-6409PE-11MMC
Description	CHOOSE WHITE COLOR YOU WANTED

MATERIAL	SP PLASTIC
MOQ	1000 PCS

MODEL NO	RJ-6409PE-15MMB
Description	WHITE, BLACK COLOR

MODEL NO	RJ-6409PE-15MMC
Description	CHOOSE WHITE COLOR YOU WANTED

MATERIAL	SP PLASTIC
MOQ	1000 PCS





ONE STEP
Fits Our Shank adapter
OVER LOCK & COVER STITCH

機
縫

台灣製造 一品質 服務客製化

FOR HOME OVERLOCK/COVER STITCH NOT FOR INDUSTRIAL



HEMMING GUIDE

MODEL NO	RJ-6788
Description	6-9MM
MATERIAL	ZINC ALLOY, METAL, PLASTIC
MOQ	100 PCS



VELVET FOOT

MODEL NO	RJ-6789
Description	GOLD COLOR
MATERIAL	ZINC ALLOY, METAL,
MOQ	10 PCS



ADJUSTABLE SEAM GUIDE

MODEL NO	RJ-6790
Description	ADJUSTABLE
MATERIAL	METAL PLASTIC
MOQ	10 SETS



SHIRRING FOOT

MODEL NO	RJ-6791
Description	GATHERING
MATERIAL	ZINC ALOY METAL
MOQ	50 PCS



BLIND STITCH FOOT

MODEL NO	RJ-6792N
Description	ADJUSTABLE
MATERIAL	ZINC ALLOY PLASTIC
MOQ	100 PCS



BEADING FOOT

MODEL NO	RJ-6793
Description	BEADING
MATERIAL	ZINC AOLLOY
MOQ	100 PCS



COVER HEM SET

MODEL NO	RJ-6794(E)	INCLUDES 1. COVER HEM FOOT LACE ATTACHMENT 2. HEM GUIDE 3. WRAPPED EDGE GUIDE
Description	SET	
MATERIAL	PLASTIC METAL	
MOQ	100 SETS	

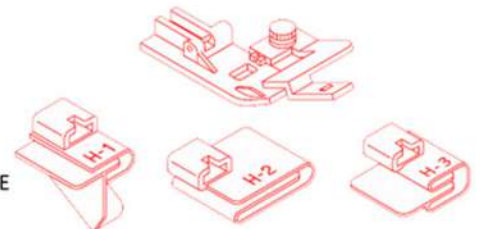

BINDER FOOT

MODEL NO	RJ-6795
Description	ADJUSTABLE
MATERIAL	PLASTIC METAL
MOQ	100 PCS



SLIDING GUIDE FOOT

MODEL NO	RJ-6796
Description	ADJUSTABLE
MATERIAL	PLASTIC METAL
MOQ	100 SETS



**POPULAR!
OVERLOCKER
SNAP ON FEET
ACCESSORIES**

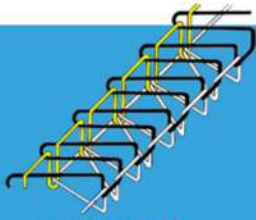

MODEL NO	RJ-8801
Description	SNAP ON OVERLOCKER SHANK
MATERIAL	ZINC ALLOY, PLASTIC METAL
MOQ	100 PCS

MADE IN TAIWAN | OVLOCKER

ARRANGE USE THESE OVERLOCKER FEET WITH SHANK RJ-8801

台灣製造 一品質 服務客製化



**CLEAR
STANDARD FOOT**

MODEL NO	RJ-8802
Description	CLEAR
MATERIAL	PLASTIC
MOQ	500 PCS



**CLEAR
TAPE BINDING FOOT**

MODEL NO	RJ-8803
Description	CLEAR
MATERIAL	PLASTIC
MOQ	500 PCS



**CLEAR
FLAT LACE FOOT**

MODEL NO	RJ-8804
Description	CLEAR
MATERIAL	PLASTIC
MOQ	500 PCS



**CLEAR
FOLDING LACE FOOT**

MODEL NO	RJ-8805
Description	CLEAR
MATERIAL	PLASTIC
MOQ	500 PCS



B FOOT

MODEL NO	RJ-8806
Description	HINGED
MATERIAL	ZINC ALLOY
MOQ	100 SETS



A FOOT

MODEL NO	RJ-8807
Description	HINGED
MATERIAL	ZINC ALLOY
MOQ	100 SETS



0.5MM BLIND STITCH FOOT

MODEL NO	RJ-8808
Description	SNAP ON
MATERIAL	ZINC AOOLY
MOQ	100 PCS



1.0MM BLIND STITCH FOOT

MODEL NO	RJ-8809
Description	SNAP ON
MATERIAL	ZINC ALLOY
MOQ	100 PCS



GATHERING/SHIRRING FOOT

MODEL NO	RJ-8810
Description	SNAP ON
MATERIAL	ZINC ALLOY
MOQ	100 PCS



ELASTIC FOOT (HINGED)

MODEL NO	RJ-8811
Description	SNAP ON
MATERIAL	ZINC ALLOY
MOQ	100 PCS



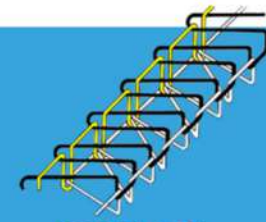

**POPULAR!
OVERLOCKER
SNAP ON FEET
ACCESSORIES**



MODEL NO	RJ-8801
Description	SNAP ON OVERLOCKER SHANK
MATERIAL	ZINC ALLOY, PLASTIC METAL
MOQ	100 PCS

MADE IN TAIWAN | OVLOCKER

ARRANGE USE THESE OVERLOCKER FEET WITH SHANK RJ-8801

台灣製造 一品質 服務客製化



MODEL NO	RJ-8812
Description	HINGED
MATERIAL	ZINC ALLOY
MOQ	100 SETS

PIPING FOOT (HINGED)



MODEL NO	RJ-8813
Description	HINGED 1.0 ZINC ALLOY
MATERIAL	100SETS
MOQ	

1.0MM BLIND STITCH FOOT (HINGED)



MODEL NO	RJ-8814
Description	SNAP ON
MATERIAL	ZINC ALLOY
MOQ	100 PCS

ELASTIC FOOT



MODEL NO	RJ-8815
Description	SNAP ON
MATERIAL	ZINC ALLOY
MOQ	100 PCS

PIPING FOOT



MODEL NO	RJ-8816
Description	SNAP ON
MATERIAL	ZINC ALLOY
MOQ	100 PCS

PEARLS/SEQUINS FOOT



MODEL NO	RJ-8817
Description	HEAVY
MATERIAL	ZINC ALLOY
MOQ	100 PCS

STANDARD FOOT (HEAVEY)



機 縫



SEWING NEEDLES
1. FOR SEWING MACHINES
2. FOR HAND SEWING

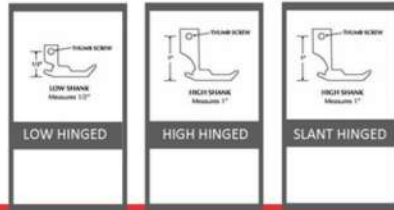

E.G. PHOTO

PLEASE CHECK OUR PACK FOR NEEDLES.
 5 NEEDLES IN 1 WHITE OR ORANGE COLOR BOX PACK
 (FOR SEWING MACHINES)

- * AVAILABLE TYPE
1. BLUE, PURPLE, RED, ETC COLOR (UNIVERSAL)
 2. ONLY SLIVER COLOR (UNIVERSAL)

DESIGN YOUR OWN BRAND TO US.
 WE WILL STICK ON THE BOX.

MODEL NO	RJ-N7311	MODEL NO	RJ-NR7311
Description	#11	Description	#11
MATERIAL	BLUE COLOR	MATERIAL	SLIVER
MOQ	3000 BOX	MOQ	500 BOX
MODEL NO	RJ-N7314	MODEL NO	RJ-NR7314
Description	#14	Description	#14
MATERIAL	RED COLOR	MATERIAL	SLIVER
MOQ	3000 BOX	MOQ	500 BOX
MODEL NO	RJ-N7316	MODEL NO	RJ-NR7316
Description	#16	Description	#16
MATERIAL	GREEN	MATERIAL	SLIVER
MOQ	3000 BOX	MOQ	500 BOX
MODEL NO	RJ-N7312	MODEL NO	RJ-NR7312
Description	#12	Description	#12
MATERIAL	RED COLOR	MATERIAL	SLIVER
MOQ	3000 BOX	MOQ	500 BOX
MODEL NO	RJ-NR7309	MODEL NO	RJ-NR7318
Description	#9	Description	#18
MATERIAL	SLIVER	MATERIAL	SLIVER
MOQ	500 BOX	MOQ	500 BOX

WHITE COLOR BOX PACK

ORANGE COLOR BOX PACK

MODEL NO	RJ-OG7311	MODEL NO	RJ-OG7316DE
Description	#11	Description	#16 DE
MATERIAL	BLUE	MATERIAL	SLIVER DE
MOQ	500 BOX	MOQ	500 BOX
MODEL NO	RJ-OG7314	MODEL NO	RJ-OG731114ST
Description	#14	Description	#11, 14 ST
MATERIAL	RED	MATERIAL	SLIVER ST
MOQ	500 BOX	MOQ	500 BOX
MODEL NO	RJ-73111416	MODEL NO	RJ-OG7311ST
Description	#11, 14, 16LL	Description	#11 ST
MATERIAL	SLIVER LL	MATERIAL	SLIVER ST
MOQ	500 BOX	MOQ	500 BOX
MODEL NO	RJ-OG7314LL	MODEL NO	RJ-OT7314ST
Description	#14 LL	Description	#14 ST
MATERIAL	SLIVER LL	MATERIAL	SLIVER ST
MOQ	500 BOX	MOQ	500 BOX
MODEL NO	RJ-OG7316LL		
Description	#16LL		
MATERIAL	SLIVER LL		
MOQ	500 BOX		

* BALL POINT ORANGE COLOR BOX PACK ↓

MODEL NO	RJ-731114BP	MODEL NO	RJ-7311BP	MODEL NO	RJ-7314BP
Description	#11, 14 BP	Description	#11	Description	#14
MATERIAL	BALL POINT	MATERIAL	BALL POINT	MATERIAL	BALL POINT
MOQ	500 BOX	MOQ	500 BOX	MOQ	500 BOX



縫紉機

SEWING MACHINES



MADE IN TAIWAN | NEW!



2016 NEW

THE SEWING MACHINES

RENUYI

MADE IN TAIWAN

WHITE LABEL



MODEL NO	RJ-98200
Description	200 STITCHES
MATERIAL	ZINC ALLOY
MOQ	300 SETS

Adjustable width of stitch : 0~7 mm
 Adjustable length of stitch: 0~5 mm
 Maximum length of reverse stitch : 3 mm
 Dimension :42cm * 21cm * 30cm
 60 units of stitch memory



Horizontal rotary hook 200 built-in stitches (Alphabet) SEWING MACHINE

WHITE LABEL



MODEL NO	RJ-99192
Description	192 STITCHES
MATERIAL	ZINC ALLOY
MOQ	300 SETS

Adjustable width of stitch : 0~7 mm
 Adjustable length of stitch: 0~4 mm
 Maximum length of reverse stitch : 3 mm
 Dimension :37cm * 19cm * 30cm
 LED lighting for working space



Horizontal rotary hook 192 built-in stitches (Alphabet) SEWING MACHINE

WHITE LABEL



MODEL NO	RJ-99168
Description	66/99 STITCH
MATERIAL	ZINC ALLOY
MOQ	300 SETS

UNIQUE



MODEL NO	RJ-PR750
Description	3-4 THREADS
MATERIAL	ZINC ALLOY
MOQ	100 SETS

Please note we do not make sewing machine with white housing, we only make different housing from the market. please see the following example picture.



台灣製造 一品質 服務 客製化



SEWING THREADS



MADE IN TAIWAN | NEW!



2016 NEW
SEWING
THREADS

RENJYI

MADE IN TAIWAN



PLEASE WRITE MAIL TO US
WE HAVE 500 DIFFERENT COLOR FOR CHOSE.

COP TYPE SEWING THREADS



VICONE TYPE SEWING THREADS



MADE IN TAIWAN SINCE 1951 NOW & FOREVER

THE SEWING MACHINE
SEWING FEET FACTORY

機
縫



ONE STEP
Fits Our Shank adapter

USE OUR SHANK
RJ-809/RJ-811/RJ-813/RJ-815

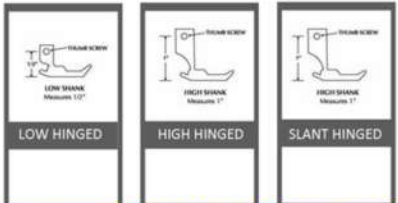

ALL SNAP ON (ONE STEP) SEWING FEET CAN BE MADE IN THE FOLLOWING TYPE

SHANK (SEE PAGE 49.)
RJ-809 = OLD TYPE
RJ-811 = NEW TYPE
RJ-813 = OLD TYPE
RJ-815 = NEW TYPE



- FOR
1. LOW SOLID SEWING FEET
 2. LOW HINGED SEWING FEET
 3. HIGH SOLID SEWING FEET
 4. HIGH HINGED SEWING FEET



For all models in category A of the accessories catalogue, presser feet with the 2-point shank opening are used.

For all the remaining models in categories B to H of the accessories catalogue, presser feet with the closed shank opening are used.

EVERY SEWING FEET CAN BE USED FOR THESE SHANK ADAPTER, PLEASE WRITE MAIL TO US FOR THE DETIAL.



Use our C Shank with the Bernina low shank adapter if you do not have the capability to snap our feet on. Once you have our c shank on you can snap on our feet onto it. You can also snap on the new snap on Bernina feet.

MADE IN TAIWAN



RENJYI



• **RENJYI** CONTACT US

RENJYI ENTERPRISE CO., LTD.

MAIL : renjyico1965@gmail.com

TEL: +886-4-23397706